



# SLG10S-020SAR21D10

SLG-2

**AUTOMATION LIGHT GRIDS**

**SICK**  
Sensor Intelligence.



Illustration may differ

### Ordering information

Type	part no.
SLG10S-020SAR21D10	1133013

Other models and accessories → [www.sick.com/SLG-2](http://www.sick.com/SLG-2)



### Detailed technical data

#### Features

<b>Included with delivery</b>	1 × sender 1 × receiver 1 × Quick Start Guide 1 × safety notes
<b>Functional principle</b>	Sender/receiver
<b>Sensing range</b>	
Limit values	440 mm ... 4,900 mm
Parallel beam (recommended)	440 mm ... 3,500 mm
3 x cross beam (recommended)	440 mm ... 3,500 mm
<b>Blind zone</b>	
Distance from 1st Beam to leading edge of housing (connection side)	4.6 mm
Distance from last beam to leading edge of housing (top)	4.6 mm <sup>1)</sup>
<b>Detection height</b>	200 mm
<b>Beam separation</b>	10 mm
<b>Optical light exit</b>	Slim
<b>Detection capability</b>	
Minimum detectable object (MDO), parallel beam	15 mm <sup>2)</sup>

<sup>1)</sup> For a detection height < 700 mm, the measured value can vary by up to 1 mm from the measured values specified here.

<sup>2)</sup> MDO: Minimum detectable size of an arbitrarily shaped object.

<sup>3)</sup> Depends on the sensing range / number of beams / cross beam.

Minimum detectable object (MDO), 3 x cross beam	$\geq 9 \text{ mm}^2$ <sup>2)</sup>
<b>Factory setting</b>	
Beam function	3 x cross beam
Pin 2 (MF)	Teach-in input
Pin 4 (OUT)	Object detection output = "HIGH"
IO-Link (process data)	Q <sub>L</sub> /Q <sub>int</sub> Status, System status, Beam status
Teach-in (default)	Auto teach-in
<b>Adjustment</b>	
IO-Link	For configuring the sensor parameters and Smart Task functions
<b>Emitted beam</b>	
Light source	LED
Type of light	Infrared light
Number of beams	20
<b>LED key figures</b>	
Normative reference	EN 62471:2008-09   IEC 62471:2006, modified
LED risk group marking	Free group
Wave length	850 nm
Average service life	Average service life: 100,000 h at T <sub>U</sub> = +25 °C
<b>Time specifications</b>	
Initialization time	0.4 s ... 2 s <sup>3)</sup>
Teach-in time	0.75 s ... 50 s <sup>3)</sup>
Scan time, parallel beam	1.3 ms
Scan time, cross beam	2.6 ms
Repeatability, parallel beam	1.3 ms
Repeatability, cross beam	4 ms
Minimum dwell time, parallel beam	2.6 ms
Minimum dwell time, cross beam	5.3 ms
Max. response time, parallel beam	4 ms
Max. response time, cross beam	8.2 ms
<b>Type of synchronization</b>	Optical (2 beams)

<sup>1)</sup> For a detection height < 700 mm, the measured value can vary by up to 1 mm from the measured values specified here.

<sup>2)</sup> MDO: Minimum detectable size of an arbitrarily shaped object.

<sup>3)</sup> Depends on the sensing range / number of beams / cross beam.

## Communication interface

<b>IO-Link</b>	✓, V1.1
Data transmission rate	COM3 (230,4 kBaud)
Cycle time	2.3 ms
Process data length	32 Byte
Maximum cable length	20 m

### Electronics

<b>Supply voltage <math>U_B</math></b>	DC 18 V DC ... 30 V DC <sup>1)</sup>
<b>Ripple</b>	$\leq 1.3 V_{pp}$
<b>Power consumption</b>	
Sender	$\leq 36.5 \text{ mA}$ <sup>2)</sup>
Receiver	$\leq 51 \text{ mA}$ <sup>2)</sup>
<b>Digital output</b>	
Number	2
Type	Push-pull: PNP/NPN
Output signal voltage HIGH/LOW	$U_B - 3 \text{ V} / < 3 \text{ V}$
Output load, Inductive	1 H
Output load, capacitive	100 nF
Output current $I_{max.}$	100 mA
Output current, rest	< 0.5 mA
<b>Digital input</b>	
Number	1
Input signal voltage HIGH/LOW	> 15 V / < 5 V
<b>Protection class</b>	III <sup>3)</sup>
<b>UL File No.</b>	NRKH.E181493 & NRKH7.E181493
<b>Circuit protection</b>	$U_V$ connections, reverse polarity protected Output Q short-circuit protected Outputs overcurrent and short-circuit protected

<sup>1)</sup> Without load.

<sup>2)</sup> At 24 V.

<sup>3)</sup> EN 61140.

### Mechanics

<b>Dimensions (W x H x D)</b>	
Width	11.8 mm
Height	199.2 mm
Depth	24.1 mm
<b>Connection type</b>	Cable with M12 male connector, 4-pin
<b>Connection type Detail</b>	
Cable diameter	3.4 mm
Conductor cross section	0.14 mm <sup>2</sup>
Length of cable	150 mm
Cable material	PVC
<b>Material</b>	
Housing	Aluminum Plastic
Front screen	PMMA
<b>Weight</b>	760 g
<b>Overvoltage protection (required)</b>	1

Ambient data

<b>Enclosure rating</b>	IP65 <sup>1)</sup> IP67
<b>Ambient temperature, operation</b>	-25 °C ... +55 °C
<b>Ambient temperature, storage</b>	-25 °C ... +70 °C
<b>Ambient light immunity</b>	Indirect: 50,000 lx <sup>2)</sup>
<b>Shock resistance</b>	10 g, 16 ms, DIN EN 60068-2-27
<b>Vibration resistance</b>	10-150 Hz 0.5 mm, IEC 60068-2-6
<b>Air humidity</b>	≤ 96 %, relative humidity (no condensation)
<b>Electromagnetic compatibility (EMC)</b>	EN 61000-6-2, EN 61000-6-4

<sup>1)</sup> Operating in outdoor condition only with a external protection housing.

<sup>2)</sup> Sunlight.

Smart Task

<b>Smart Task name</b>	Base logics
<b>Logic function</b>	Direct AND OR
<b>Timer function</b>	Deactivated Switch-on delay Off delay ON and OFF delay Impulse (one shot)
<b>Switching signal</b>	
Switching signal Q <sub>L1</sub>	Switching output
Switching signal Q <sub>L2</sub>	Switching output, external input

Diagnosis

<b>Diagnostics functions</b>	
Device state	Hardware error, temperature warning, operating hours warning
Communication state	Pin short-circuit error, invalid process data
Status of the light signal	Teach error, synchronization error, quality-of-run alarm
Alarm output	Yes

Certificates

<b>EU declaration of conformity</b>	✓
<b>UK declaration of conformity</b>	✓
<b>ACMA declaration of conformity</b>	✓
<b>Moroccan declaration of conformity</b>	✓
<b>China-RoHS</b>	✓
<b>cULus certificate</b>	✓
<b>IO-Link</b>	✓
<b>Photobiological safety (IEC EN 62471)</b>	✓
<b>Information according to Art. 3 of Data Act (Regulation EU 2023/2854)</b>	✓

Classifications

<b>ECLASS 5.0</b>	27270910
-------------------	----------

<b>ECLASS 5.1.4</b>	27270910
<b>ECLASS 6.0</b>	27270910
<b>ECLASS 6.2</b>	27270910
<b>ECLASS 7.0</b>	27270910
<b>ECLASS 8.0</b>	27270910
<b>ECLASS 8.1</b>	27270910
<b>ECLASS 9.0</b>	27270910
<b>ECLASS 10.0</b>	27270910
<b>ECLASS 11.0</b>	27270910
<b>ECLASS 12.0</b>	27270910
<b>ETIM 5.0</b>	EC002549
<b>ETIM 6.0</b>	EC002549
<b>ETIM 7.0</b>	EC002549
<b>ETIM 8.0</b>	EC002549
<b>UNSPSC 16.0901</b>	39121528

### Dimensional drawing, sensor



Dimensions in mm (inch)

SLGxxx-xxxSxxxxxxx

① First beam

- ② last beam
- ③ beam separation (RM)
- ④ Housing length
- ⑤ LED display receiver
- ⑥ LED display sender

Dimensions in mm (inch)		
-	Length of stabilizer	Housing length
	<b>A</b>	<b>L</b>
SLGxxx- <b>010</b> xxxxxxxx	77 (3.03)	99,2 (3.91)
SLGxxx- <b>020</b> xxxxxxxx	178 (7.01)	199,2 (7.84)
SLGxxx- <b>030</b> xxxxxxxx	276 (10.87)	299,2 (11.78)
SLGxxx- <b>040</b> xxxxxxxx	376 (14.8)	399,2 (15.72)
SLGxxx- <b>050</b> xxxxxxxx	475 (18.7)	499,2 (19.65)
SLGxxx- <b>060</b> xxxxxxxx	576 (22.68)	599,2 (23.6)
SLGxxx- <b>070</b> xxxxxxxx	676 (26.61)	699,2 (27.53)
SLGxxx- <b>080</b> xxxxxxxx	776 (30.55)	799,2 (31.46)
SLGxxx- <b>100</b> xxxxxxxx	975 (38.39)	999,2 (39.34)
SLGxxx- <b>120</b> xxxxxxxx	1.175 (46.26)	1.199,2 (47.21)
SLGxxx- <b>140</b> xxxxxxxx	1.374 (54.09)	1.399,2 (55.09)
SLGxxx- <b>160</b> xxxxxxxx	1.574 (61.97)	1.599,2 (62.96)
SLGxxx- <b>180</b> xxxxxxxx	1.774 (69.84)	1.799,2 (70.83)
SLGxxx- <b>200</b> xxxxxxxx	1.973 (77.68)	1.999,2 (78.71)
SLGxxx- <b>220</b> xxxxxxxx	2.173 (85.55)	2.199,2 (86.58)
SLGxxx- <b>240</b> xxxxxxxx	2.372 (93.39)	2.399,2 (94.46)
-	-	-
-	Distance: Housing edge - last beam	-
	<b>B<sup>1)</sup></b>	
SLG <b>10</b> x-xxxxxxxxxxx	4,6 (0.18)	
SLG <b>25</b> x-xxxxxxxxxxx	19,6 (0.77)	
SLG <b>50</b> x-xxxxxxxxxxx	44,6 (1.76)	

<sup>1)</sup> for detection height less than 700 mm, the dimension deviates up to 1 mm from the dimensions specified here.

### dimensional drawing, connection type

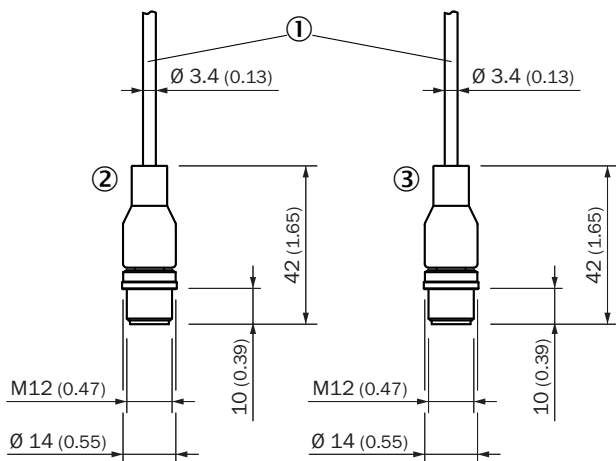

Dimensions in mm (inch)

Cable with M12 male connector

① connection (see technical data for length of cable)

② receiver

③ sender

### pinouts

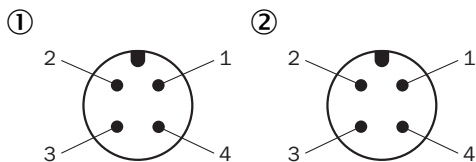

M12 male connector, 4-pin, A-coding

① receiver

② sender

### Connection diagram

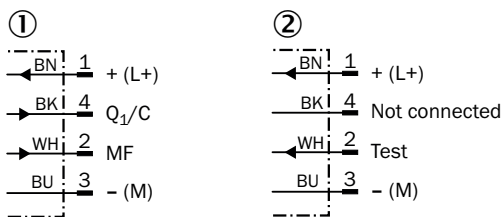

cd-543

① receiver

② sender

Instruction for installation Minimum distance to reflective materials



Depending on the sensing range, make sure that there are no reflective objects in the field of view of the light grid pair

- ① Minimum distance (safe)
- ② Minimum distance (typical)

Instruction for installation Minimum distance between 2 light grids



If not installed in opposition, make sure the minimum distance between the two light grid pairs is adhered to

- ① Minimum distance (safe)
- ② Minimum distance (typical)

### Instruction for installation Slim & Flat



- ① Slim model = light emission on narrow side
- ② Flat model = light emission on broad side

### Detection capability Minimum detectable object (MDO)



$d_{LG}$  = Installed working distance between sender and receiver  
 $d$  = Distance to sender or receiver related to the installed working distance

### Functional principle Optical synchronization

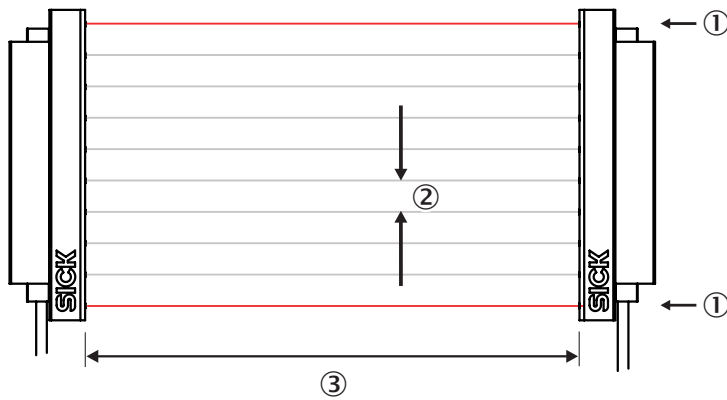









The sender and receiver synchronize with each other optically, so no electrical connection is necessary. For this reason, either the first or the last beam of the automation light grid must remain clear. If both beams are interrupted, no measurements can be taken.

- ① Optical synchronization
- ② Beam separation
- ③ scanning range

### Recommended accessories

Other models and accessories → [www.sick.com/SLG-2](http://www.sick.com/SLG-2)

	Brief description	Type	part no.
Mounting systems			
	<ul style="list-style-type: none"> <li>• <b>Description:</b> Mounting bracket for switching automation light grids, SLG-2</li> <li>• <b>Packing unit:</b> 4 pieces</li> </ul>	BEF-SLG2-SET1	2111623

	Brief description	Type	part no.
network devices			
		SIG350-0004AP100	6076871
		SIG350-0005AP100	6076923
		SIG350-0006AP100	6076924
connectors and cables			
	<ul style="list-style-type: none"> <li>• <b>Connection type head A:</b> Female connector, M12, 4-pin, straight, A-coded</li> <li>• <b>Connection type head B:</b> Flying leads</li> <li>• <b>Signal type:</b> Sensor/actuator cable</li> <li>• <b>Cable:</b> 5 m, 4-wire, PUR, halogen-free</li> <li>• <b>Description:</b> Sensor/actuator cable, unshielded</li> <li>• <b>Application:</b> Uncontaminated zones, Zones with oils and lubricants, Robot, Drag chain operation</li> </ul>	YF2A14-050UB3XLEAX	2095608
	<ul style="list-style-type: none"> <li>• <b>Connection type head A:</b> Female connector, M12, 4-pin, straight, A-coded</li> <li>• <b>Connection type head B:</b> Male connector, M12, 4-pin, straight, A-coded</li> <li>• <b>Signal type:</b> Sensor/actuator cable</li> <li>• <b>Cable:</b> 5 m, 4-wire, PUR, halogen-free</li> <li>• <b>Description:</b> Sensor/actuator cable, unshielded</li> <li>• <b>Application:</b> Uncontaminated zones, Zones with oils and lubricants, Robot, Drag chain operation</li> </ul>	YF2A14-050UB3M2A14	2096001
	<ul style="list-style-type: none"> <li>• <b>Connection type head A:</b> Male connector, M12, 5-pin, A-coded</li> <li>• <b>Connection type head B:</b> Female connector, M12, 5-pin, A-coded</li> <li>• <b>Connection type head C:</b> Female connector, M12, 3-pin, A-coded</li> <li>• <b>Description:</b> Unshielded</li> </ul>	YM2A15-000S01FY2A5	2099606
integration modules and adapters			
	<ul style="list-style-type: none"> <li>• <b>Description:</b> External, passive control unit with one pushbutton and three LEDs. Cable with male connector M12, 4-pin; cable material: PUR; housing material: plastic, TPU, reinforced; supply voltage: DC 10 V DC ... 30 V DC; current I<sub>max.</sub>: 510 mA; protection class: III (EN 61140); EMC: EN 61000-6-2, EN 61000-6-4; ambient temperature operation: -25 °C ... +55 °C; ambient temperature storage: -25 °C ... +70 °C</li> </ul>	ECU1-2121AAZZZ	2118078

## SICK AT A GLANCE

SICK is one of the leading manufacturers of intelligent sensors and sensor solutions for industrial applications. A unique range of products and services creates the perfect basis for controlling processes securely and efficiently, protecting individuals from accidents and preventing damage to the environment.

We have extensive experience in a wide range of industries and understand their processes and requirements. With intelligent sensors, we can deliver exactly what our customers need. In application centers in Europe, Asia and North America, system solutions are tested and optimized in accordance with customer specifications. All this makes us a reliable supplier and development partner.

Comprehensive services complete our offering: SICK LifeTime Services provide support throughout the machine life cycle and ensure safety and productivity.

For us, that is “Sensor Intelligence.”

## WORLDWIDE PRESENCE:

Contacts and other locations –[www.sick.com](http://www.sick.com)