



MLG05W-0200N12503

MLG-2 WebChecker

AUTOMATION LIGHT GRIDS

SICK
Sensor Intelligence.



Ordering information

| Type | part no. |
|-------------------|----------|
| MLG05W-0200N12503 | 1130858 |

Other models and accessories → www.sick.com/MLG-2_WebChecker

Illustration may differ



Detailed technical data

Features

| | |
|---|---|
| Device version | Web guiding |
| Sensor principle | Sender/receiver |
| Minimum object length | 4 mm ¹⁾ |
| Beam separation | 5 mm |
| Resolution | 0.1 mm |
| Cycle time | 32 µs per beam |
| Repeatability | 6 µm ²⁾ |
| Accuracy | ± 0.3 mm ³⁾ |
| Type of synchronization | Cable |
| Number of beams | 60 |
| Total measuring field width | 295 mm |
| Measuring field width detailed | |
| Measuring field width (connection side) | 295 mm |
| Blind zone (medium range) | 0 mm |
| Measuring field width (head side) | 0 mm |
| Software features (default) | |
| Q ₁ | Alarm, general |
| Application | High resolution mode |
| Included with delivery | 1 × sender 1 × receiver 1 × Fieldbus module 4/6 × QuickFix brackets (6 × QuickFix brackets for monitoring heights above 2 m) |

¹⁾ See graphic: product definition.

²⁾ 1 sigma, 0% object transmission (sensor internal value).

³⁾ Typical 0.1 mm. For opaque objects and exact alignment of sender/receiver.

1 × Quick Start Guide

¹⁾ See graphic: product definition.

²⁾ 1 sigma, 0% object transmission (sensor internal value).

³⁾ Typical 0.1 mm. For opaque objects and exact alignment of sender/receiver.

Mechanics/electronics

| | |
|--|--|
| Light source | LED, Infrared light |
| Wave length | 850 nm |
| Supply voltage V_s | DC 19.2 V ... 28.8 V ¹⁾ |
| Power consumption sender | 58 mA ²⁾ |
| Power consumption receiver | 132 mA ²⁾ |
| Fieldbus module current consumption | 115 mA |
| Ripple | < 5 V _{pp} |
| Output current I_{max} | 100 mA |
| Output load, capacitive | 100 nF |
| Output load, Inductive | 1 H |
| Initialization time | < 1 s |
| Switching output | Push-pull: PNP/NPN |
| Dimensions (W x H x D) | 34 mm x 379.4 mm x 30.6 mm |
| Connection type | Plug, M12, 5-pin, 0.22 m Connector M12, 12-pin, 0.27 m |
| Housing material | Aluminum |
| Display | LED |
| Enclosure rating | IP65, IP67 ³⁾ |
| Circuit protection | U _V connections, reverse polarity protected Output Q short-circuit protected Interference pulse suppression |
| Protection class | III |
| Weight | 0.859 kg |
| Front screen | PMMA |
| Option | None |
| UL File No. | NRKH.E181493 |

¹⁾ Without load.

²⁾ Without load with 24 V.

³⁾ Operating in outdoor condition only with a external protection housing.

Performance

| | |
|------------------------|-----------------------|
| Maximum range | 3.5 m ¹⁾ |
| Minimum range | ≥ 0.2 m |
| Operating range | 2.5 m |
| Response time | 13.1 ms ²⁾ |

¹⁾ No reserve for environmental issue and deterioration of the diode.

²⁾ With resistive load.

Interfaces

| | |
|-----------------------|----------------|
| PROFINET | ✓ |
| Digital output | Q ₁ |
| Number | 1 |

Ambient data

| | |
|--------------------------------------|--|
| Shock resistance | Continuous shocks 10 g, 16 ms, 1000 shocks Single shocks 15 g, 11 ms 3 per axle |
| Vibration resistance | Sinusoidal oscillation 10-150 Hz 5 g |
| Ambient light immunity | 100,000 lx |
| Ambient operating temperature | -30 °C ... +55 °C |
| Ambient temperature, storage | -40 °C ... +70 °C |

Certificates

| | |
|--|---|
| EU declaration of conformity | ✓ |
| UK declaration of conformity | ✓ |
| ACMA declaration of conformity | ✓ |
| Moroccan declaration of conformity | ✓ |
| China-RoHS | ✓ |
| cULus certificate | ✓ |
| Photobiological safety (IEC EN 62471) | ✓ |
| Information according to Art. 3 of Data Act (Regulation EU 2023/2854) | ✓ |

Classifications

| | |
|-----------------------|----------|
| ECLASS 5.0 | 27270910 |
| ECLASS 5.1.4 | 27270910 |
| ECLASS 6.0 | 27270910 |
| ECLASS 6.2 | 27270910 |
| ECLASS 7.0 | 27270910 |
| ECLASS 8.0 | 27270910 |
| ECLASS 8.1 | 27270910 |
| ECLASS 9.0 | 27270910 |
| ECLASS 10.0 | 27270910 |
| ECLASS 11.0 | 27270910 |
| ECLASS 12.0 | 27270910 |
| ETIM 5.0 | EC002549 |
| ETIM 6.0 | EC002549 |
| ETIM 7.0 | EC002549 |
| ETIM 8.0 | EC002549 |
| UNSPSC 16.0901 | 39121528 |

Dimensional drawing

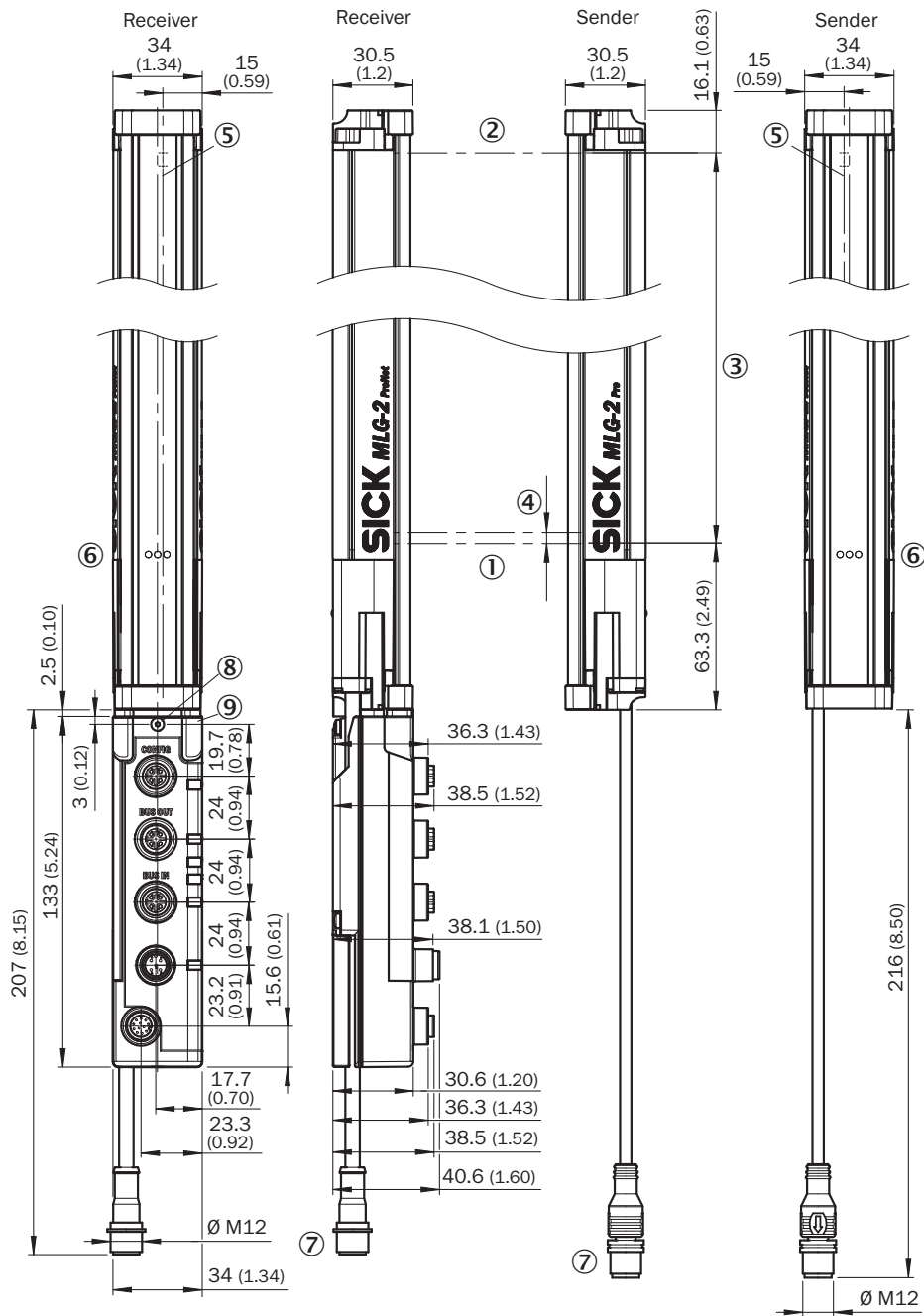

Dimensions in mm (inch)

- ① First beam
- ② last beam
- ③ total measuring field width (see technical data)
- ④ Beam separation
- ⑤ Optical axis
- ⑥ status indicator: green, yellow, red LEDs
- ⑦ Connection

Dimensional drawing PROFINET, EtherCAT[®], EtherNet/IP



Dimensions in mm (inch)

① safety screw M4; turning moment 0,5 Nm

② for thread bold M4; turning moment 0,5 Nm

Connection type and diagram MLG-2 WebChecker



① Connection to fieldbus module

Pinouts Ethernet



Adjustments

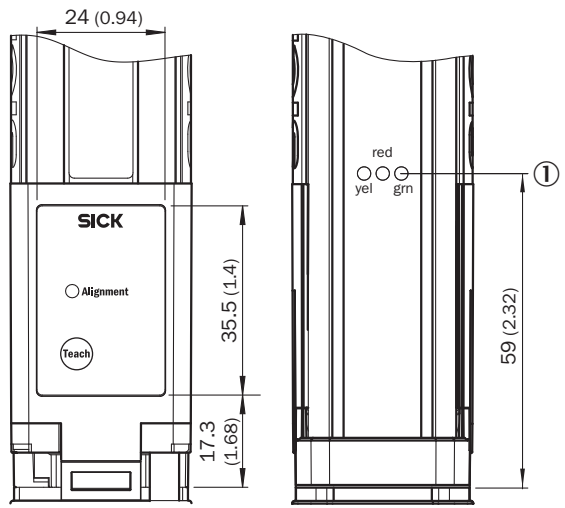

① status indicator: green, yellow, red LEDs

Connection diagram T-piece









Product definition



- ① operating range
- ② total measuring field width
- ③ measuring field width (head side)
- ④ Blind zone (medium range)
- ⑤ measuring field width (connection side)
- ⑥ sender
- ⑦ receiver
- ⑧ Beam separation
- ⑨ minimum object length

Recommended accessories

Other models and accessories → www.sick.com/MLG-2_WebChecker

| | Brief description | Type | part no. |
|---|---|---------------------|----------|
| connectors and cables | | | |
|  | <ul style="list-style-type: none"> • Connection type head A: Female connector, M12, 5-pin, A-coded • Connection type head B: Female connector, M12, 5-pin, A-coded • Connection type head C: Male connector, M12, 4-pin, A-coded • Description: Unshielded | SBO-02G12-SM | 6029305 |
|  | <ul style="list-style-type: none"> • Connection type head A: Male connector, M12, 4-pin, D-coded • Connection type head B: Male connector, M12, 4-pin, D-coded • Signal type: Ethernet • Cable: 5 m, 4-wire, PUR, halogen-free • Description: Ethernet, twisted pair, shielded • Permitted cross-section: ≥ 0.25 mm² • Application: Zones with oils and lubricants | YM2D24-050EA2M2D24 | 6034422 |
|  | <ul style="list-style-type: none"> • Connection type head A: Female connector, M12, 5-pin, straight, A-coded • Connection type head B: Flying leads • Signal type: Sensor/actuator cable • Cable: 5 m, 5-wire, PVC • Description: Sensor/actuator cable, unshielded • Application: Zones with chemicals, Uncontaminated zones | YF2A15-050VB5XLEAX | 2096240 |
|  | <ul style="list-style-type: none"> • Connection type head A: Female connector, M12, 5-pin, straight, A-coded • Connection type head B: Male connector, M12, 5-pin, straight, A-coded • Signal type: Sensor/actuator cable • Cable: 5 m, 5-wire, PUR, halogen-free • Description: Sensor/actuator cable, unshielded • Application: Uncontaminated zones, Zones with oils and lubricants, Robot, Drag chain operation | YF2A15-050UB5M2A15 | 2096010 |
|  | <ul style="list-style-type: none"> • Connection type head A: Male connector, M12, 4-pin, straight, D-coded • Connection type head B: Male connector, RJ45, 4-pin, straight • Signal type: Ethernet, PROFINET • Cable: 5 m, 4-wire, PUR, halogen-free • Description: Ethernet, shielded, PROFINET • Application: Drag chain operation, Zones with oils and lubricants | YM2D24-050P-N1MRJA4 | 2106184 |
| Mounting systems | | | |
|  | <ul style="list-style-type: none"> • Description: Mounting bracket for external mounting of the fieldbus module, 1 × mounting bracket and 1 × M5 × 6 screw • Material: Stainless steel • Details: Stainless steel V2A (1.4301) | BEF-WN-FBM-SET1 | 2082322 |

SICK AT A GLANCE

SICK is one of the leading manufacturers of intelligent sensors and sensor solutions for industrial applications. A unique range of products and services creates the perfect basis for controlling processes securely and efficiently, protecting individuals from accidents and preventing damage to the environment.

We have extensive experience in a wide range of industries and understand their processes and requirements. With intelligent sensors, we can deliver exactly what our customers need. In application centers in Europe, Asia and North America, system solutions are tested and optimized in accordance with customer specifications. All this makes us a reliable supplier and development partner.

Comprehensive services complete our offering: SICK LifeTime Services provide support throughout the machine life cycle and ensure safety and productivity.

For us, that is “Sensor Intelligence.”

WORLDWIDE PRESENCE:

Contacts and other locations –www.sick.com