



SAS4-F028N3PS1W01

SLG

AUTOMATION LIGHT GRIDS

SICK
Sensor Intelligence.



Ordering information

Type	part no.
SAS4-F028N3PS1W01	1214757

Other models and accessories → www.sick.com/SLG

Illustration may differ



Detailed technical data

Features

Sensor principle	Sender/receiver
Minimum detectable object (MDO)	Cross beam, 25 mm
Beam separation	40 mm
Optical light exit	Flat
Number of beams	8
Detection height	280 mm
Parameterization	None
Cross beam/parallel beam	Cross beam active
Output 1	Output 1 active, if light beam interrupted
Muting function	Muting function deactivated
Automatic teach	Automatic teach inactive
Alignment aid	Without alignment aid

Mechanics/electronics

Light source	Infrared light
Wave length	950 nm
Supply voltage V_s	DC24 V, $\pm 20\%$
Power consumption receiver	≤ 70 mA
Ripple	$< 5 V_{pp}$
Output current I_{max}	≤ 100 mA
Output load, capacitive	100 nF
Output load, Inductive	1 H
Initialization time	1 s
Switching output	NPN

Inputs	Teach-in input (receiver) Test input (sender) HIGH = 10 V ... 30 V / LOW = < 5 V
Dimensions (W x H x D)	25 mm x 352.4 mm x 8.2 mm
Connection type	Cable with M8 male connector, 4-pin
Housing material	PMMA
Indication	LED
Synchronization	Optical
Enclosure rating	IP65
Circuit protection	U _V connections, reverse polarity protected Output Q short-circuit protected Interference pulse suppression
Protection class	III
Weight	40 g
Pulse frequency	500 kHz
Aluminum stabilizer	Without stabilizer

Performance

Maximum range	4 m ¹⁾
Minimum range	Cross beam: ≥ 0.3 m ²⁾
Operating range	3 m
Response time	Cross beam, 57 ms

¹⁾ No reserve for environmental issue and deterioration of the diode.

²⁾ Aperture ± 10°.

Ambient data

Shock resistance	10 g / DIN EN 60068-2-29 / 16 ms
Vibration resistance	5 g, 10 Hz ... 55 Hz (IEC 68-2-6)
EMC	EN 60947-5-2
Ambient light immunity	Direct: 100,000 lx ¹⁾ Indirect: 150,000 lx
Ambient operating temperature	-25 °C ... +55 °C
Ambient temperature, storage	-25 °C ... +70 °C

¹⁾ Sunlight.

Certificates

EU declaration of conformity	✓
UK declaration of conformity	✓
ACMA declaration of conformity	✓
Moroccan declaration of conformity	✓
China RoHS	✓
Information according to Art. 3 of Data Act (Regulation EU 2023/2854)	✓

Classifications

ECLASS 5.0	27270910
-------------------	----------

ECLASS 5.1.4	27270910
ECLASS 6.0	27270910
ECLASS 6.2	27270910
ECLASS 7.0	27270910
ECLASS 8.0	27270910
ECLASS 8.1	27270910
ECLASS 9.0	27270910
ECLASS 10.0	27270910
ECLASS 11.0	27270910
ECLASS 12.0	27270910
ETIM 5.0	EC002549
ETIM 6.0	EC002549
ETIM 7.0	EC002549
ETIM 8.0	EC002549
UNSPSC 16.0901	39121528

Dimensional drawing Sxx-Fxxxxxx1xxx

Flat, without stabilizer

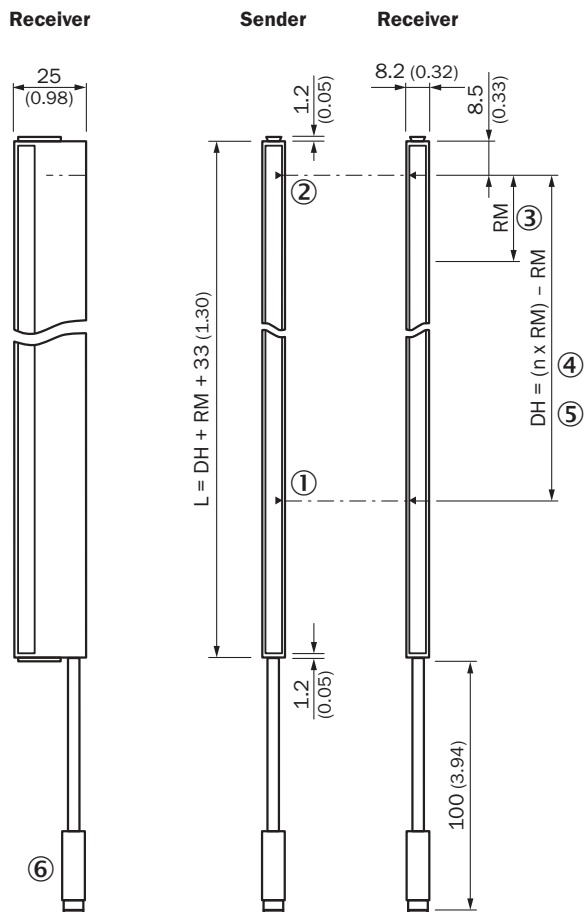

Dimensions in mm (inch)

- ① First beam
- ② last beam
- ③ beam separation (RM)
- ④ number of beams (n)
- ⑤ detection height (DH)
- ⑥ Connection

Connection type and diagram

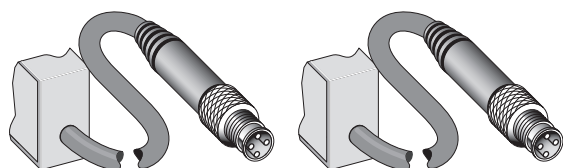

Sender

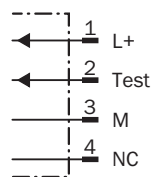

Receiver

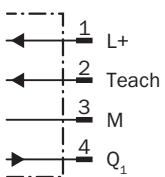

Specific features

Optical synchronization

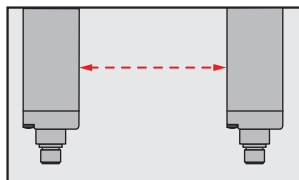

The light grid communicates via the light beams. A cable is not necessary for the optical synchronization.





Slim & Flat



- ① Slim model = light emission on narrow side
- ② Flat model = light emission on broad side

Recommended accessories

Other models and accessories → www.sick.com/SLG

	Brief description	Type	part no.
Mounting systems			
	<ul style="list-style-type: none"> • Description: Mounting bracket for light grids from a detection height of 600 mm (with slot, recommended for compensation of material extension caused by temperature), mounting position: front • Items supplied: 2x BEF-SLG1, 2x BEF-SLG2 	BEF-SLG-SET1	2055427
connectors and cables			
	<ul style="list-style-type: none"> • Connection type head A: Female connector, M8, 4-pin, straight, A-coded • Connection type head B: Flying leads • Signal type: Sensor/actuator cable • Cable: 2 m, 4-wire, PVC • Description: Sensor/actuator cable, unshielded • Application: Zones with chemicals, Uncontaminated zones 	YF8U14-020VA3XLEAX	2095888
	<ul style="list-style-type: none"> • Connection type head A: Female connector, M8, 4-pin, straight, A-coded • Connection type head B: Flying leads • Signal type: Sensor/actuator cable • Cable: 0.6 m, 4-wire, PVC • Description: Sensor/actuator cable, unshielded • Application: Zones with chemicals, Uncontaminated zones 	YF8U14-C60VA3XLEAX	2145852
	<ul style="list-style-type: none"> • Connection type head A: Female connector, M8, 4-pin, straight, A-coded • Connection type head B: Flying leads • Signal type: Sensor/actuator cable • Cable: 1 m, 4-wire, PVC • Description: Sensor/actuator cable, unshielded • Application: Zones with chemicals, Uncontaminated zones 	YF8U14-010VA3XLEAX	2145853

SICK AT A GLANCE

SICK is one of the leading manufacturers of intelligent sensors and sensor solutions for industrial applications. A unique range of products and services creates the perfect basis for controlling processes securely and efficiently, protecting individuals from accidents and preventing damage to the environment.

We have extensive experience in a wide range of industries and understand their processes and requirements. With intelligent sensors, we can deliver exactly what our customers need. In application centers in Europe, Asia and North America, system solutions are tested and optimized in accordance with customer specifications. All this makes us a reliable supplier and development partner.

Comprehensive services complete our offering: SICK LifeTime Services provide support throughout the machine life cycle and ensure safety and productivity.

For us, that is “Sensor Intelligence.”

WORLDWIDE PRESENCE:

Contacts and other locations –www.sick.com