



WL9M4G-3P2434

W9

PHOTOELECTRIC SENSORS

SICK
Sensor Intelligence.



Ordering information

Type	part no.
WL9M4G-3P2434	1067619

Other models and accessories → www.sick.com/W9

Illustration may differ

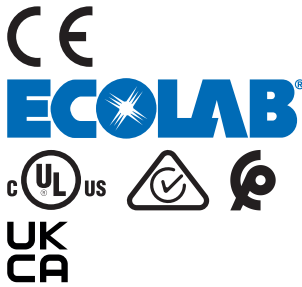

Detailed technical data

Features

Functional principle	Photoelectric retro-reflective sensor
Functional principle detail	Without reflector minimum distance (autocollimation/coaxial optics)
Dimensions (W x H x D)	12.2 mm x 52.2 mm x 23.6 mm
Housing design (light emission)	Rectangular
Mounting hole	M4
Sensing range max.	0 m ... 5 m ¹⁾
Sensing range	0 m ... 3 m ¹⁾
Type of light	Visible red light
Light source	PinPoint LED ²⁾
Light spot size (distance)	Ø 45 mm (1.5 m)
Wave length	650 nm
Adjustment	Single teach-in button
AutoAdapt	✓
Special feature	Detecting transparent objects
Special applications	Detecting transparent objects

¹⁾ Reflector PL80A.

²⁾ Average service life: 100,000 h at T_U = +25 °C.

Mechanics/electronics

Supply voltage U_B	10 V DC ... 30 V DC ¹⁾
Ripple	< 5 V _{pp} ²⁾
Current consumption	20 mA ³⁾
Switching output	PNP ⁴⁾
Switching mode	Light switching ⁴⁾
Output current I_{max}	≤ 100 mA ⁵⁾
Response time	< 0.5 ms ⁶⁾
Switching frequency	1,000 Hz ⁷⁾
Connection type	Male connector M12, 4-pin
Circuit protection	A ⁸⁾ B ⁹⁾ C ¹⁰⁾
Protection class	III
Weight	13 g
Polarizing filter	✓
Housing material	Plastic, VISTAL®
Optics material	Plastic, PMMA
Enclosure rating	IP66 IP67 IP69K
Special feature	Detecting transparent objects
Ambient operating temperature	-40 °C ... +60 °C
Ambient temperature, storage	-40 °C ... +75 °C
UL File No.	NRKH.E181493

¹⁾ Limit values when operated in short-circuit protected network: max. 8 A.

²⁾ May not fall below or exceed U_V tolerances.

³⁾ Without load.

⁴⁾ Q = light switching.

⁵⁾ At and above T_u 50 °C, a max. load current of $I_{max} = 50$ mA is permitted.

⁶⁾ Signal transit time with resistive load.

⁷⁾ With light/dark ratio 1:1.

⁸⁾ A = V_S connections reverse-polarity protected.

⁹⁾ B = inputs and output reverse-polarity protected.

¹⁰⁾ C = interference suppression.

Safety-related parameters

MTTF_D	1,232 years
DC_{avg}	0 %

Classifications

ECLASS 5.0	27270902
ECLASS 5.1.4	27270902
ECLASS 6.0	27270902
ECLASS 6.2	27270902

ECLASS 7.0	27270902
ECLASS 8.0	27270902
ECLASS 8.1	27270902
ECLASS 9.0	27270902
ECLASS 10.0	27270902
ECLASS 11.0	27270902
ECLASS 12.0	27270902
ETIM 5.0	EC002717
ETIM 6.0	EC002717
ETIM 7.0	EC002717
ETIM 8.0	EC002717
UNSPSC 16.0901	39121528

Certificates

EU declaration of conformity	✓
UK declaration of conformity	✓
ACMA declaration of conformity	✓
Moroccan declaration of conformity	✓
China-RoHS	✓
ECOLAB certificate	✓
cULus certificate	✓
Photobiological safety (DIN EN 62471) certificate	✓

Adjustments Single teach-in button

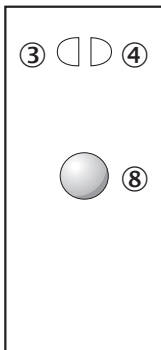

- ③ LED indicator yellow: Status of received light beam
- ④ LED indicator green: power on
- ⑧ Teach-in button

Connection type

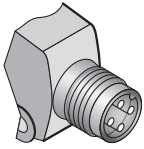

Connection diagram Cd-092

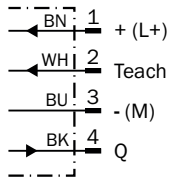

Characteristic curve WL9G-3

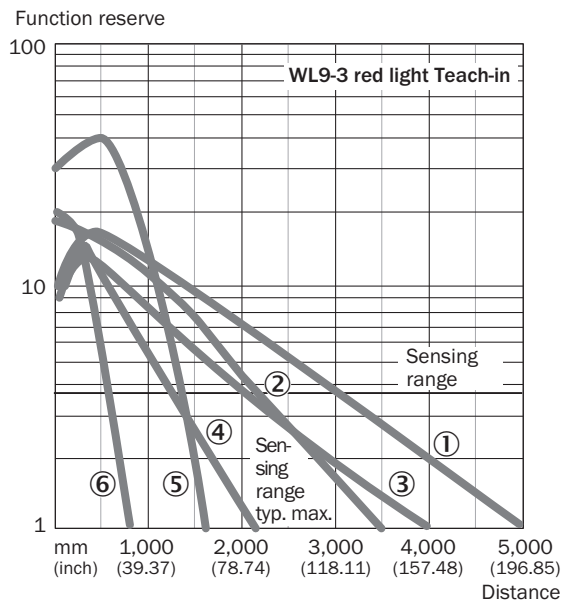

- ① Reflector PL80A
- ② Reflector P250F
- ③ Reflector PL40A
- ④ Reflector PL20F
- ⑤ PL10F reflector
- ⑥ Reflective tape REF-IRF-56

Light spot size

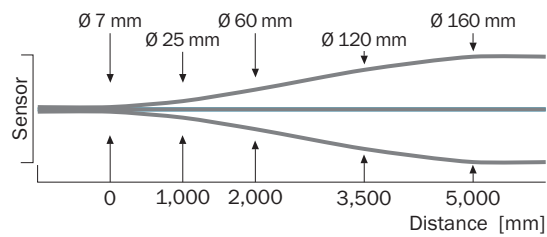

Sensing range diagram WL9G-3

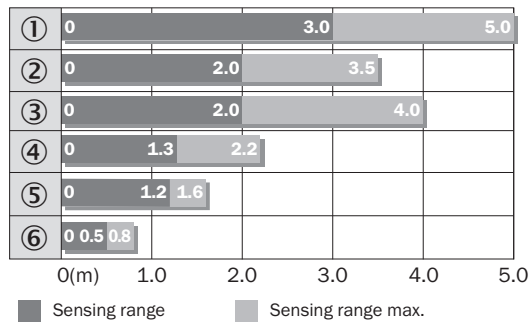

- ① Reflector PL80A
- ② Reflector P250F
- ③ Reflector PL40A
- ④ Reflector PL20F
- ⑤ PL10F reflector
- ⑥ Reflective tape REF-IRF-56

Dimensional drawing WL9M4-3, WSE9M4-3

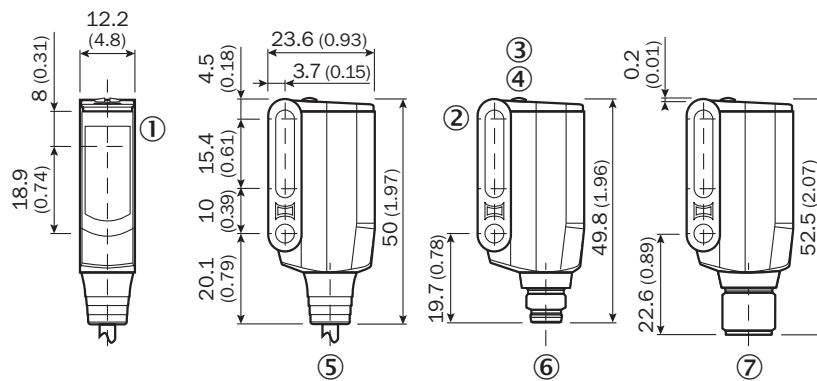





Dimensions in mm (inch)

- ① Sender and receiver optical axis center
- ② Mounting hole M4 (Ø 4.1 mm)
- ③ LED indicator yellow: Status of received light beam
- ④ LED indicator green: power on
- ⑤ Connecting cable or connector
- ⑥ male connector M8, 4-pin
- ⑦ male connector M12, 4-pin

Recommended accessories

Other models and accessories → www.sick.com/W9

	Brief description	Type	part no.
Mounting systems			
	<ul style="list-style-type: none"> Description: Plate N08 for universal clamp bracket Material: Steel, zinc diecast Details: Zinc plated steel (sheet), Zinc die cast (clamping bracket) Items supplied: Universal clamp (5322626), mounting hardware Usable for: W100, W150, W4S, W4F, W8, W9-3, W8G, W8 Laser, W8 Inox, G6, W100 Laser, W100-2, W10, G6 Inox, RAY10, W4SLG-3, W9, GR18, MultiPulse, Reflex Array, MultiLine, LUT3, KT5, KT8, KT10, CS8 	BEF-KHS-N08	2051607
	<ul style="list-style-type: none"> Description: Plate N11N for universal clamp bracket Material: Stainless steel Details: Stainless steel 1.4571 (sheet), Stainless steel 1.4408 (clamp) Items supplied: Universal clamp (5322627), mounting hardware Usable for: DeltaPac, Glare, WTD20E 	BEF-KHS-N11N	2071081
reflectors and optics			
	<ul style="list-style-type: none"> Description: Fine triple reflector, screw connection, suitable for laser sensors Dimensions: 52 mm 62 mm Ambient operating temperature: -30 °C ... +65 °C 	P250F	5308843
connectors and cables			
	<ul style="list-style-type: none"> Connection type head A: Female connector, M12, 4-pin, straight, A-coded Connection type head B: Flying leads Signal type: Sensor/actuator cable Cable: 5 m, 4-wire, PVC Description: Sensor/actuator cable, unshielded Application: Zones with chemicals, Uncontaminated zones 	YF2A14-050VB3XLEAX	2096235
	<ul style="list-style-type: none"> Connection type head A: Male connector, M12, 4-pin, straight, A-coded Description: Unshielded Connection systems: Screw-type terminals Permitted cross-section: ≤ 0.75 mm² 	STE-1204-G	6009932
	<ul style="list-style-type: none"> Connection type head A: Female connector, M12, 4-pin, straight, A-coded Connection type head B: Flying leads Signal type: Sensor/actuator cable Cable: 5 m, 4-wire, PUR, halogen-free Description: Sensor/actuator cable, unshielded Application: Uncontaminated zones, Zones with oils and lubricants, Robot, Drag chain operation 	YF2A14-050UB3XLEAX	2095608

SICK AT A GLANCE

SICK is one of the leading manufacturers of intelligent sensors and sensor solutions for industrial applications. A unique range of products and services creates the perfect basis for controlling processes securely and efficiently, protecting individuals from accidents and preventing damage to the environment.

We have extensive experience in a wide range of industries and understand their processes and requirements. With intelligent sensors, we can deliver exactly what our customers need. In application centers in Europe, Asia and North America, system solutions are tested and optimized in accordance with customer specifications. All this makes us a reliable supplier and development partner.

Comprehensive services complete our offering: SICK LifeTime Services provide support throughout the machine life cycle and ensure safety and productivity.

For us, that is “Sensor Intelligence.”

WORLDWIDE PRESENCE:

Contacts and other locations –www.sick.com