



# C2C-SA18030A10000

deTec

**SAFETY LIGHT CURTAINS**

**SICK**  
Sensor Intelligence.



### Ordering information

| Type              | part no. |
|-------------------|----------|
| C2C-SA18030A10000 | 1213220  |

Other models and accessories → [www.sick.com/deTec](http://www.sick.com/deTec)

Illustration may differ



### Detailed technical data

#### Features

|                                |                               |
|--------------------------------|-------------------------------|
| <b>Product version</b>         | deTec2 Core                   |
| <b>Application</b>             | Normal industrial environment |
| <b>System part</b>             | Sender                        |
| <b>Compatible receiver</b>     | 1213221                       |
| <b>Resolution</b>              | 30 mm                         |
| <b>Scanning range</b>          | 15 m                          |
| <b>Protective field height</b> | 1,800 mm                      |
| <b>No blind zones</b>          | Yes                           |
| <b>Synchronization</b>         | Optical synchronization       |
| <b>Items supplied</b>          | Sender                        |

#### Safety-related parameters

|   |  |
|---|--|
| <b>Type</b>   | Type 2 (IEC 61496-1)                   |
| <b>Safety integrity level</b>   | SIL 1 (IEC 61508)                      |
| <b>Category</b>   | Category 2 (ISO 13849-1)               |
| <b>Performance level</b>  | PL c (ISO 13849-1)                     |
| <b>PFH<sub>D</sub> (mean probability of a dangerous failure per hour)</b> | $31 \times 10^{-9}$                    |
| <b>T<sub>M</sub> (mission time)</b>                                       | 20 years (ISO 13849-1)                 |
| <b>Safe state in the event of a fault</b>                                 | At least one OSSD is in the OFF state. |

#### Functions

|                             |   |
|-----------------------------|---|
| <b>Protective operation</b> | ✓ |
|-----------------------------|---|

|  |   |
|--|---|
| <b>Automatic calibration of the protective field width</b> | ✓ |
|--|---|

## Interfaces

|                          |                       |
|--------------------------|-----------------------|
| <b>System connection</b> | Plug, M12, 5-pin      |
| Length of cable          | 150 mm                |
| Cable diameter           | 4.3 mm                |
| <b>Cable bend radius</b> |                       |
| Stationary position      | > 12 x cable diameter |
| Flexible use             | > 15 x cable diameter |
| <b>Display elements</b>  | LEDs                  |

## Electronics

|  |                             |
|--|-----------------------------|
| <b>Protection class</b>                | III (IEC 61140)             |
| <b>Supply voltage <math>V_s</math></b> | 24 V DC (19.2 V ... 28.8 V) |
| <b>Ripple</b>                          | ≤ 10 %                      |
| <b>Power consumption typical</b>       | 1.3 W (DC)                  |

## Mechanics

|                         |                           |
|-------------------------|---------------------------|
| <b>Dimensions</b>       | See dimensional drawing   |
| <b>Housing material</b> | Aluminum extruded profile |

## Ambient data

|                                      |   |
|--------------------------------------|---|
| <b>Enclosure rating</b>              | IP65 (IEC 60529)<br>IP67 (IEC 60529)      |
| <b>Ambient operating temperature</b> | -30 °C ... +55 °C                         |
| <b>Storage temperature</b>           | -30 °C ... +70 °C                         |
| <b>Air humidity</b>                  | 15 % ... 95 %, Non-condensing             |
| <b>Vibration resistance</b>          | 5 ... 150 Hz, 3,5 mm / 1 g (EN 60068-2-6) |
| <b>Shock resistance</b>              | 15 g / 6 ms (EN 60068-2-27)               |
| <b>Class</b>                         | 3M4 (IEC TR 60721-4-3)                    |

## Other information

|                      |                                |
|----------------------|--------------------------------|
| <b>Wave length</b>   | 850 nm                         |
| <b>Type of light</b> | Near-infrared (NIR), invisible |

## Certificates

|   |   |
|---|---|
| <b>EU declaration of conformity</b>       | ✓ |
| <b>UK declaration of conformity</b>       | ✓ |
| <b>ACMA declaration of conformity</b>     | ✓ |
| <b>Moroccan declaration of conformity</b> | ✓ |
| <b>China-RoHS</b>                         | ✓ |
| <b>ULus approval</b>                      | ✓ |
| <b>cUL approval</b>                       | ✓ |
| <b>Taiwan OSHA certificate</b>            | ✓ |
| <b>EC-Type-Examination approval</b>       | ✓ |
| <b>China GB certificate</b>               | ✓ |

|   |   |
|---|---|
| China GB/T certificate  | ✓ |
| Information according to Art. 3 of Data Act (Regulation EU 2023/2854) | ✓ |

### Classifications

|                       |          |
|-----------------------|----------|
| <b>ECLASS 5.0</b>     | 27272704 |
| <b>ECLASS 5.1.4</b>   | 27272704 |
| <b>ECLASS 6.0</b>     | 27272704 |
| <b>ECLASS 6.2</b>     | 27272704 |
| <b>ECLASS 7.0</b>     | 27272704 |
| <b>ECLASS 8.0</b>     | 27272704 |
| <b>ECLASS 8.1</b>     | 27272704 |
| <b>ECLASS 9.0</b>     | 27272704 |
| <b>ECLASS 10.0</b>    | 27272704 |
| <b>ECLASS 11.0</b>    | 27272704 |
| <b>ECLASS 12.0</b>    | 27272704 |
| <b>ETIM 5.0</b>       | EC002549 |
| <b>ETIM 6.0</b>       | EC002549 |
| <b>ETIM 7.0</b>       | EC002549 |
| <b>ETIM 8.0</b>       | EC002549 |
| <b>UNSPSC 16.0901</b> | 46171620 |

### Dimensional drawing

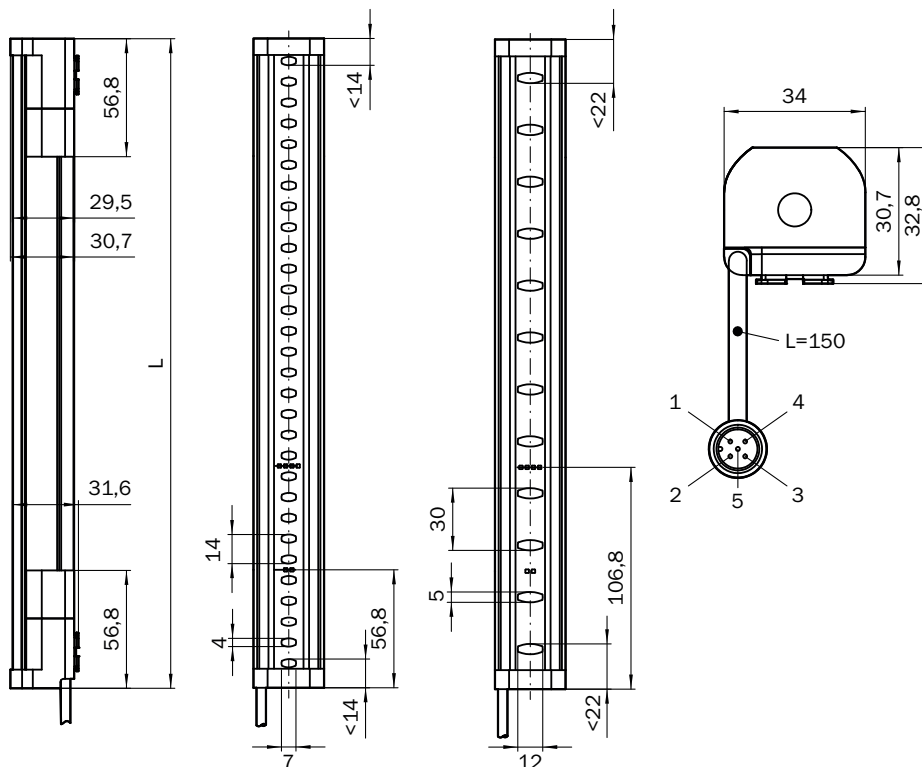

Dimensions in mm (inch)

| Protective field height | L             |
|-------------------------|---------------|
| 300 (11.81)             | 313 (12.32)   |
| 450 (17.72)             | 463 (18.23)   |
| 600 (23.62)             | 613 (24.13)   |
| 750 (29.53)             | 763 (30.04)   |
| 900 (35.43)             | 913 (35.94)   |
| 1,050 (41.34)           | 1,063 (41.85) |
| 1,200 (47.24)           | 1,213 (47.76) |
| 1,350 (53.15)           | 1,362 (53.62) |
| 1,500 (59.06)           | 1,512 (59.53) |
| 1,650 (64.96)           | 1,662 (65.43) |
| 1,800 (70.87)           | 1,812 (71.34) |
| 1,950 (76.77)           | 1,962 (77.24) |
| 2,100 (82.68)           | 2,112 (83.15) |

Connection diagram deTec2 Core safety light curtain to RLY3-OSSD2 safety relay

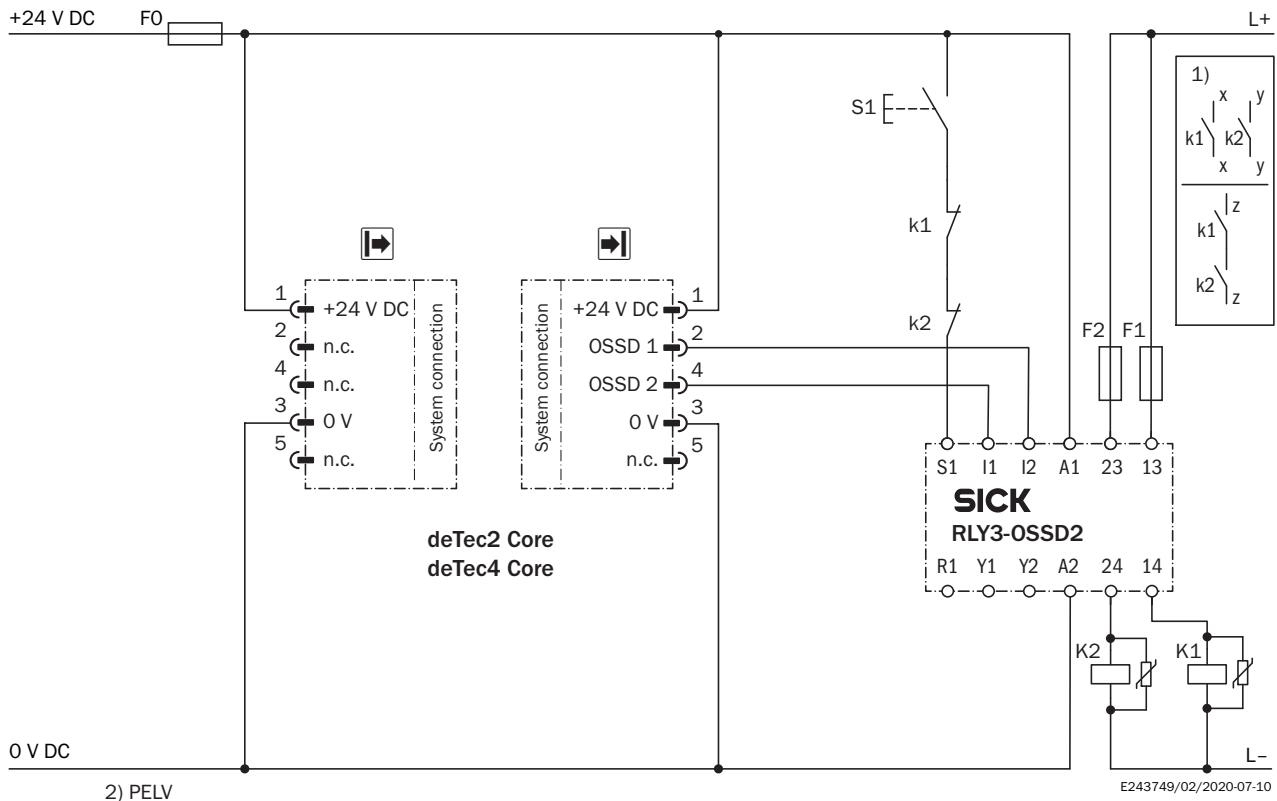

**Task**

Connection of a deTec2 Core safety light curtain to RLY3-OSSD2.  
 Operating mode: with restart interlock and external device monitoring.

**Function**

When the protective field is clear, the OSSD1 and OSSD2 outputs carry voltage. The system can be switched on when K1 and K2 are in a fault-free de-energized position. The RLY3-OSSD2 is switched on by pressing S1 (pushbutton is pressed and released). The

outputs (contacts 13-14 and 23-24) switch the K1 and K2 contactors on. When the protective field is interrupted, the OSSD1 and OSSD2 outputs switch the RLY3-OSSD2 off. Contactors K1 and K2 are switched off.

### Fault analysis

Cross-circuits and short-circuits of the OSSDs are recognized and lead to the locking status (lock-out). A malfunction with one of the K1 or K2 contactors is detected. The switch-off function is retained. In the event of manipulation (e.g., jamming) of the S1 pushbutton, the RLY3-OSSD2 will not re-enable the output current circuits.





### Comments







<sup>1)</sup> Output circuits: These contacts must be incorporated into the control such that the dangerous state is brought to an end if the output circuit is open. For categories 4 and 3, they must be incorporated on dual-channels (x, y paths). Type 2 devices are suitable for use up to PL c. Single-channel incorporation into the control (z path) is only possible with a singlechannel control and taking the risk analysis into account.

<sup>2)</sup> SELV/PELV safety extra-low voltage.

## Recommended accessories

Other models and accessories → [www.sick.com/deTec](http://www.sick.com/deTec)

|   | Brief description   | Type          | part no. |
|---|---|---------------|----------|
| Safety relays   |   |               |          |
|    | <ul style="list-style-type: none"> <li>• <b>Applications:</b> Evaluation unit</li> <li>• <b>Compatible sensor types:</b> Safety sensors with OSSDs</li> <li>• <b>Connection type:</b> Front connector with spring terminals</li> <li>• <b>Restart interlock:</b> yes</li> <li>• <b>External device monitoring (EDM):</b> Integrated</li> <li>• <b>Outputs:</b> 3 enabling current paths (safe), 2 application diagnostic outputs (not safe), 1 test pulse output (not safe)</li> <li>• <b>Housing width:</b> 18 mm</li> </ul> | RLY3-OSSD300  | 1099969  |
|  | <ul style="list-style-type: none"> <li>• <b>Applications:</b> Evaluation unit</li> <li>• <b>Compatible sensor types:</b> Safety sensors with OSSDs</li> <li>• <b>Connection type:</b> Front connector with spring terminals</li> <li>• <b>Restart interlock:</b> yes</li> <li>• <b>External device monitoring (EDM):</b> Integrated</li> <li>• <b>Outputs:</b> 2 enabling current paths (safe), 2 application diagnostic outputs (not safe), 1 test pulse output (not safe)</li> <li>• <b>Housing width:</b> 18 mm</li> </ul> | RLY3-OSSD200  | 1085344  |
| Mounting systems  |   |               |          |
|  | <ul style="list-style-type: none"> <li>• <b>Description:</b> QuickFix bracket for 2 devices (e.g. sender and receiver)</li> <li>• <b>Material:</b> Plastic</li> <li>• <b>Details:</b> Plastic</li> <li>• <b>Packing unit:</b> 4 pieces</li> </ul>   | BEF-3SHABPKU4 | 2098710  |
|  | <ul style="list-style-type: none"> <li>• <b>Description:</b> FlexFix bracket for 2 devices (e.g. sender and receiver), can be aligned ± 15°, including M5 screw</li> <li>• <b>Material:</b> Plastic</li> <li>• <b>Details:</b> Plastic</li> <li>• <b>Packing unit:</b> 4 pieces</li> </ul>  | BEF-1SHABPKU4 | 2066614  |

|   | Brief description  | Type               | part no. |
|---|--|--------------------|----------|
| connectors and cables   |  |                    |          |
|    | <ul style="list-style-type: none"> <li>• <b>Connection type head A:</b> Female connector, M12, 5-pin, A-coded</li> <li>• <b>Connection type head B:</b> Female connector, M12, 5-pin, A-coded</li> <li>• <b>Connection type head C:</b> Male connector, M12, 5-pin, A-coded</li> <li>• <b>Description:</b> Unshielded</li> </ul>   | DSC-1205T000025KMC | 6030664  |
|    | <ul style="list-style-type: none"> <li>• <b>Connection type head A:</b> Female connector, M12, 5-pin, straight, A-coded</li> <li>• <b>Connection type head B:</b> Male connector, M12, 5-pin, straight, A-coded</li> <li>• <b>Signal type:</b> Sensor/actuator cable</li> <li>• <b>Cable:</b> 2 m, 5-wire, PUR, halogen-free</li> <li>• <b>Description:</b> Sensor/actuator cable, unshielded</li> <li>• <b>Application:</b> Uncontaminated zones, Zones with oils and lubricants, Robot, Drag chain operation</li> </ul>  | YF2A15-020UB5M2A15 | 2096009  |
|    | <ul style="list-style-type: none"> <li>• <b>Connection type head A:</b> Female connector, M12, 5-pin, straight, A-coded</li> <li>• <b>Connection type head B:</b> Flying leads</li> <li>• <b>Signal type:</b> Sensor/actuator cable</li> <li>• <b>Cable:</b> 2 m, 5-wire, PUR, halogen-free</li> <li>• <b>Description:</b> Sensor/actuator cable, unshielded</li> <li>• <b>Application:</b> Uncontaminated zones, Zones with oils and lubricants, Robot, Drag chain operation</li> </ul>                                   | YF2A15-020UB5XLEAX | 2095617  |
|    | <ul style="list-style-type: none"> <li>• <b>Connection type head A:</b> Female connector, M12, 5-pin, straight, A-coded</li> <li>• <b>Connection type head B:</b> Male connector, M12, 5-pin, straight, A-coded</li> <li>• <b>Signal type:</b> Sensor/actuator cable</li> <li>• <b>Cable:</b> 5 m, 5-wire, PUR, halogen-free</li> <li>• <b>Description:</b> Sensor/actuator cable, unshielded</li> <li>• <b>Application:</b> Uncontaminated zones, Zones with oils and lubricants, Robot, Drag chain operation</li> </ul>  | YF2A15-050UB5M2A15 | 2096010  |
|    | <ul style="list-style-type: none"> <li>• <b>Connection type head A:</b> Female connector, M12, 5-pin, straight, A-coded</li> <li>• <b>Connection type head B:</b> Flying leads</li> <li>• <b>Signal type:</b> Sensor/actuator cable</li> <li>• <b>Cable:</b> 5 m, 5-wire, PUR, halogen-free</li> <li>• <b>Description:</b> Sensor/actuator cable, unshielded</li> <li>• <b>Application:</b> Uncontaminated zones, Zones with oils and lubricants, Robot, Drag chain operation</li> </ul>                                   | YF2A15-050UB5XLEAX | 2095618  |
|   | <ul style="list-style-type: none"> <li>• <b>Connection type head A:</b> Female connector, M12, 5-pin, straight, A-coded</li> <li>• <b>Connection type head B:</b> Male connector, M12, 5-pin, straight, A-coded</li> <li>• <b>Signal type:</b> Sensor/actuator cable</li> <li>• <b>Cable:</b> 10 m, 5-wire, PUR, halogen-free</li> <li>• <b>Description:</b> Sensor/actuator cable, unshielded</li> <li>• <b>Application:</b> Uncontaminated zones, Zones with oils and lubricants, Robot, Drag chain operation</li> </ul> | YF2A15-100UB5M2A15 | 2096011  |
|  | <ul style="list-style-type: none"> <li>• <b>Connection type head A:</b> Female connector, M12, 5-pin, straight, A-coded</li> <li>• <b>Connection type head B:</b> Flying leads</li> <li>• <b>Signal type:</b> Sensor/actuator cable</li> <li>• <b>Cable:</b> 10 m, 5-wire, PUR, halogen-free</li> <li>• <b>Description:</b> Sensor/actuator cable, unshielded</li> <li>• <b>Application:</b> Uncontaminated zones, Zones with oils and lubricants, Robot, Drag chain operation</li> </ul>                                  | YF2A15-100UB5XLEAX | 2095619  |

## SICK AT A GLANCE

SICK is one of the leading manufacturers of intelligent sensors and sensor solutions for industrial applications. A unique range of products and services creates the perfect basis for controlling processes securely and efficiently, protecting individuals from accidents and preventing damage to the environment.

We have extensive experience in a wide range of industries and understand their processes and requirements. With intelligent sensors, we can deliver exactly what our customers need. In application centers in Europe, Asia and North America, system solutions are tested and optimized in accordance with customer specifications. All this makes us a reliable supplier and development partner.

Comprehensive services complete our offering: SICK LifeTime Services provide support throughout the machine life cycle and ensure safety and productivity.

For us, that is “Sensor Intelligence.”

## WORLDWIDE PRESENCE:

Contacts and other locations –[www.sick.com](http://www.sick.com)