



AS30-EBM314I220C00

AS30

ARRAY SENSORS

SICK
Sensor Intelligence.



Illustration may differ



Ordering information

Type	part no.
AS30-EBM314I220C00	1121313

Included in delivery: REF-AX-002 (1)

Other models and accessories → www.sick.com/AS30

Detailed technical data

Features

Sensor principle	Proximity system, Reflector mode
Functional principle	Web guiding, positioning
Principle of operation (default)	Web guiding
Dimensions (W x H x D)	31 mm x 62 mm x 52.2 mm
Sensing distance	≤ 25 mm
Housing design	Rectangular
Working range	20 mm ... 30 mm
Measurement range	20 mm
Minimum detectable object (MDO)	0.2 mm
Light source	LED, White
Wave length	400 nm ... 700 nm
Light spot size	38.9 mm x 11.1 mm
Repeatability	0.03 mm ¹⁾
Linearity (position value)	± 2 %
Resolution	1 μm
Adjustment	IO-Link, Display
Teach-in mode	Edge detection Area detection

¹⁾ With respect to sensing distance.

Mechanics/electronics

Supply voltage	18 V ... 30 V
Ripple	$\leq 5 \text{ V}^{1)}$
Current consumption	$< 3.1 \text{ W}^{2)}$
Switching frequency	500 Hz
Switching output	Push-pull: PNP/NPN
Switching output (voltage)	Push-pull: PNP/NPN HIGH = $U_V - 3 \text{ V}$ /LOW $\leq 3 \text{ V}$
Analog output	4 mA ... 20 mA
Resolution of analog output	12 bit
Output rate of analog output	1 ms
Output current I_{max}	$< 100 \text{ mA}$
Initialization time	0.48 s
Connection type	Male connector M12, 5-pin
Protection class	III ³⁾
Circuit protection	U_V connections, reverse polarity protected Output Q short-circuit protected Interference pulse suppression
Enclosure rating	IP67
Weight	250 g
Housing material	Zinc diecast
Optics material	Anti-reflex coating

1) May not fall below or exceed U_V tolerances.

2) Without load.

3) $I_N = 2 \text{ A}$.

Communication interface

IO-Link	✓
VendorID	26
DeviceID HEX	0x80020B
DeviceID DEC	8389131
Cycle time	$> 1.1 \text{ ms}$

Ambient data

Ambient operating temperature	$-10 \text{ °C} \dots +55 \text{ °C}$
Ambient temperature, storage	$-25 \text{ °C} \dots +75 \text{ °C}$
Shock load	According to IEC 60068
UL File No.	NRKH.E181493 & NRKH7.E181493

Smart Task

Smart Task name	Base logics
Logic function	Direct AND OR Window
Switching signal	
Switching signal Q_{L1}	Switching output

Switching signal Q _{L2}	Switching output
----------------------------------	------------------

Certificates

EU declaration of conformity	✓
UK declaration of conformity	✓
ACMA declaration of conformity	✓
Moroccan declaration of conformity	✓
China RoHS	✓
cULus certificate	✓
IO-Link	✓
Photobiological safety (IEC EN 62471)	✓
Information according to Art. 3 of Data Act (Regulation EU 2023/2854)	✓

Classifications

ECLASS 5.0	27270906
ECLASS 5.1.4	27270906
ECLASS 6.0	27270906
ECLASS 6.2	27270906
ECLASS 7.0	27270906
ECLASS 8.0	27270906
ECLASS 8.1	27270906
ECLASS 9.0	27270906
ECLASS 10.0	27270906
ECLASS 11.0	27270906
ECLASS 12.0	27270906
ETIM 5.0	EC001820
ETIM 6.0	EC001820
ETIM 7.0	EC001820
ETIM 8.0	EC001820
UNSPSC 16.0901	39121528

Dimensional drawing AS30-xxx31xxxxxxx

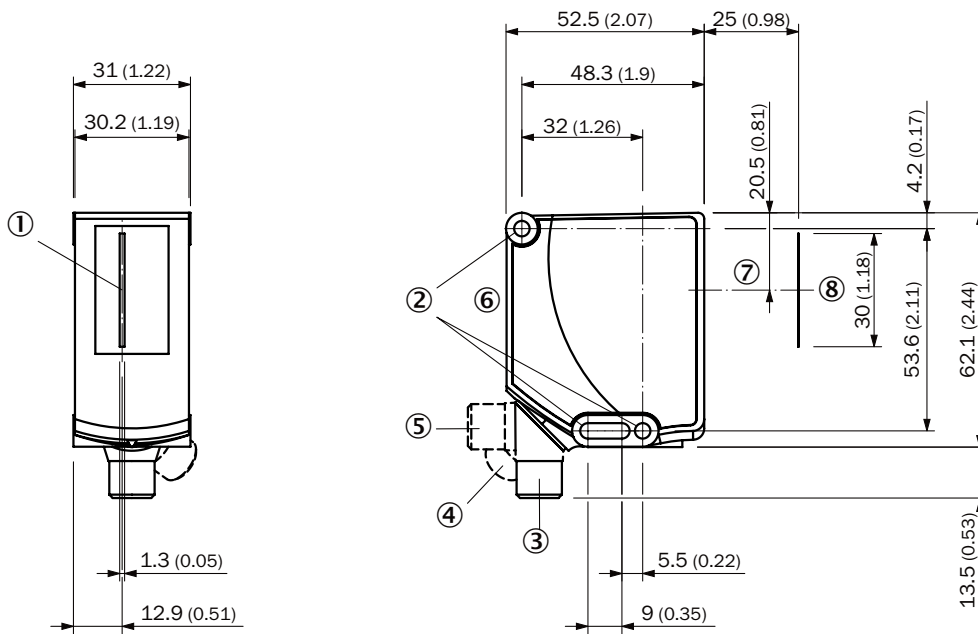

Dimensions in mm (inch)

- ① Center field of view
- ② fixing hole
- ③ M12 male connector, delivery state
- ④ M12 male connector, end stop right
- ⑤ M12 male connector, end stop left
- ⑥ display and adjustment elements
- ⑦ Optical axis
- ⑧ Field of view

display and adjustment elements

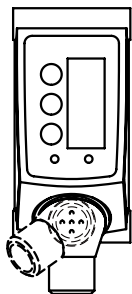



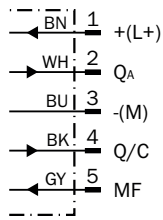



Connection diagram Cd-435



Recommended accessories

Other models and accessories → www.sick.com/AS30

	Brief description	Type	part no.
Mounting systems			
	<ul style="list-style-type: none"> Description: Holder for reflector foil (scope of delivery AS30) or accessory reflector. Simply align and set the correct scanning distance. Material: Steel Details: Steel, zinc coated Items supplied: Reflector holder, screw set for AS30 and reflector PL25FA (5340878) Suitable for: AS30 	REFLECTORHOLD-ER SD25	2107380
	<ul style="list-style-type: none"> Description: Bracket for easy mounting of ELA external illumination as a backlight. Suitable for all AS30 Prime with 25 mm sensing distance. Material: Steel Details: Steel, zinc coated Items supplied: Mounting bracket, Screw set for AS30 and ELA Suitable for: AS30, ELA, AS30 	SET FORK HOLD-ER ELA SD25	2134662
	<ul style="list-style-type: none"> Description: Plate K for universal clamp bracket Material: Steel Details: Steel, zinc coated Items supplied: Universal clamp (2022726), mounting hardware Usable for: W11-2, W12-3, W14-2, W18-3, W23-2, W24-2, W27-3, W30, W32, W34, W36, PL50A, PL80A, P250, UC12, LUT3, KT2, KT5-2, KT8, CS8, DT2, DS30, DS40, W12-2 Laser, W16, W26, KT5 	BEF-KHS-K01	2022718
	<ul style="list-style-type: none"> Material: Aluminum Details: Aluminum Items supplied: Mounting hardware for the sensor included Usable for: Adapter plate for AX20 to AS30 	BEF-AP-AS30	2124602
connectors and cables			
	<ul style="list-style-type: none"> Connection type head A: Male connector, M12, 5-pin, straight, A-coded Description: Unshielded Connection systems: Screw-type terminals Permitted cross-section: ≤ 0.75 mm² Note: For field bus technology 	STE-1205-G	6022083
	<ul style="list-style-type: none"> Connection type head A: Female connector, M12, 5-pin, straight, A-coded Connection type head B: Flying leads Signal type: Sensor/actuator cable Cable: 5 m, 5-wire, PVC Description: Sensor/actuator cable, unshielded Application: Zones with chemicals, Uncontaminated zones 	YF2A15-050VB5XLEAX	2096240

	Brief description	Type	part no.
network devices			
		SIG200-0A0412200	1089794
		SIG200-0A0G12200	1102605
		IOLA2US-01101 (SiLink2 Master)	1061790
reflectors and optics			
	<ul style="list-style-type: none"> • Description: Fine triple, planar, suitable for laser sensors • Dimensions: 75 mm 25 mm • Ambient operating temperature: -30 °C ... +65 °C 	PL25FA	5340878

SICK AT A GLANCE

SICK is one of the leading manufacturers of intelligent sensors and sensor solutions for industrial applications. A unique range of products and services creates the perfect basis for controlling processes securely and efficiently, protecting individuals from accidents and preventing damage to the environment.

We have extensive experience in a wide range of industries and understand their processes and requirements. With intelligent sensors, we can deliver exactly what our customers need. In application centers in Europe, Asia and North America, system solutions are tested and optimized in accordance with customer specifications. All this makes us a reliable supplier and development partner.

Comprehensive services complete our offering: SICK LifeTime Services provide support throughout the machine life cycle and ensure safety and productivity.

For us, that is “Sensor Intelligence.”

WORLDWIDE PRESENCE:

Contacts and other locations –www.sick.com