



KUP-0610-BJ

Shaft couplings

SHAFT ADAPTATION

SICK
Sensor Intelligence.



Ordering information

Type	part no.
KUP-0610-BJ	2124999

Other models and accessories → www.sick.com/Shaft_couplings

Detailed technical data

Features

Product segment	Shaft adaptation
Product	Shaft couplings
Description	Combination coupling: bellows & claw coupling, with emergency running property in the event of bellows fracture, shaft diameter 6 mm / 10 mm, maximum shaft offset: radial ± 0.3 mm, axial ± 0.45 , angular $\pm 3^\circ$, max. speed 10,000 rpm, -30° to $+120^\circ$ °C, max. torque 200 Ncm; material: stainless steel bellows, stainless steel flange, for use with torque feather key
Specialty	Shaft features emergency running properties. In the event of bellows coupling fracture, the claw coupling inside enables emergency rotation of the coupling. Coupling must be replaced as soon as possible after fracture. Torsion spring stiffness of 183 Nm/rad, radial spring stiffness of 17.8 N/mm, moment of inertia 9.1 gcm ² , shaft insertion depth: min: 6 mm max: 11 mm, hubs with feather keyways DIN6885 3/4 mm

Classifications

ECLASS 5.0	23031090
ECLASS 5.1.4	23031090
ECLASS 6.0	23031090
ECLASS 6.2	23031090
ECLASS 7.0	23031090
ECLASS 8.0	23031090
ECLASS 8.1	23031090
ECLASS 9.0	23031090
ECLASS 10.0	23031090
ECLASS 11.0	23031090
UNSPSC 16.0901	31163014

Certificates

China-RoHS	✓
-------------------	---

Dimensional drawing

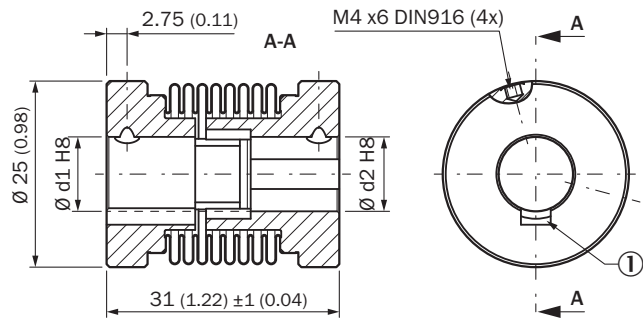

Dimensions in mm (inch)
① Threaded pin M4x6 ISO 4029

SICK AT A GLANCE

SICK is one of the leading manufacturers of intelligent sensors and sensor solutions for industrial applications. A unique range of products and services creates the perfect basis for controlling processes securely and efficiently, protecting individuals from accidents and preventing damage to the environment.

We have extensive experience in a wide range of industries and understand their processes and requirements. With intelligent sensors, we can deliver exactly what our customers need. In application centers in Europe, Asia and North America, system solutions are tested and optimized in accordance with customer specifications. All this makes us a reliable supplier and development partner.

Comprehensive services complete our offering: SICK LifeTime Services provide support throughout the machine life cycle and ensure safety and productivity.

For us, that is “Sensor Intelligence.”

WORLDWIDE PRESENCE:

Contacts and other locations –www.sick.com