

# DFS60E-S4EK00500

DFS60

INCREMENTAL ENCODERS

**SICK**  
Sensor Intelligence.



### Ordering information

Type	part no.
DFS60E-S4EK00500	1050572

Other models and accessories → [www.sick.com/DFS60](http://www.sick.com/DFS60)

Illustration may differ

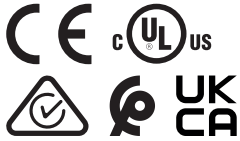

### Detailed technical data

#### Safety-related parameters

<b>MTTF<sub>D</sub> (mean time to dangerous failure)</b>	300 years (EN ISO 13849-1) <sup>1)</sup>
--	--

<sup>1)</sup> This product is a standard product and does not constitute a safety component as defined in the Machinery Directive. Calculation based on nominal load of components, average ambient temperature 40°C, frequency of use 8760 h/a. All electronic failures are considered hazardous. For more information, see document no. 8015532.

#### Performance

<b>Pulses per revolution</b>	500 <sup>1)</sup>
<b>Measuring step</b>	90°, electric/pulses per revolution
<b>Measuring step deviation at non binary number of lines</b>	± 0.2°
<b>Error limits</b>	± 0.3°

<sup>1)</sup> See maximum revolution range.

#### Interfaces

<b>Communication interface</b>	Incremental
<b>Communication Interface detail</b>	HTL / Push pull
<b>Number of signal channels</b>	6-channel
<b>Initialization time</b>	40 ms
<b>Output frequency</b>	≤ 300 kHz
<b>Load current</b>	≤ 30 mA
<b>Power consumption</b>	≤ 0.5 W (without load)

#### Electronics

<b>Connection type</b>	Cable, 8-wire, universal, 1.5 m <sup>1)</sup>
<b>Supply voltage</b>	10 ... 32 V
<b>Reference signal, number</b>	1
<b>Reference signal, position</b>	90°, electric, logically gated with A and B
<b>Reverse polarity protection</b>	✓

<sup>1)</sup> The universal cable connection is positioned so that it is possible to lay it without bends in a radial or axial direction.

<sup>2)</sup> Short-circuit opposite to another channel, US or GND permissible for maximum 30 s.

**Short-circuit protection of the outputs** ✓ <sup>2)</sup>

<sup>1)</sup> The universal cable connection is positioned so that it is possible to lay it without bends in a radial or axial direction.

<sup>2)</sup> Short-circuit opposite to another channel, US or GND permissible for maximum 30 s.

## Mechanics

<b>Mechanical design</b>	Solid shaft, face mount flange
<b>Shaft diameter</b>	10 mm With flat
<b>Shaft length</b>	19 mm
<b>Weight</b>	+ 0.3 kg
<b>Shaft material</b>	Stainless steel
<b>Flange material</b>	Aluminum
<b>Housing material</b>	Aluminum die cast
<b>Start up torque</b>	0.5 Ncm (+20 °C)
<b>Operating torque</b>	0.3 Ncm (+20 °C)
<b>Permissible shaft loading</b>	80 N (radial) 40 N (axial)
<b>Operating speed</b>	≤ 9,000 min <sup>-1</sup> <sup>1)</sup>
<b>Moment of inertia of the rotor</b>	6.2 gcm <sup>2</sup>
<b>Bearing lifetime</b>	3.6 x 10 <sup>10</sup> revolutions
<b>Angular acceleration</b>	≤ 500,000 rad/s <sup>2</sup>

<sup>1)</sup> Allow for self-heating of 3.3 K per 1,000 rpm when designing the operating temperature range.

## Ambient data

<b>EMC</b>	According to EN 61000-6-2 and EN 61000-6-4
<b>Enclosure rating</b>	IP67, housing side, cable connection (IEC 60529) IP65, shaft side (IEC 60529)
<b>Permissible relative humidity</b>	90 % (Condensation not permitted)
<b>Operating temperature range</b>	0 °C ... +85 °C
<b>Storage temperature range</b>	-40 °C ... +100 °C, without package
<b>Resistance to shocks</b>	50 g, 6 ms (EN 60068-2-27)
<b>Resistance to vibration</b>	20 g, 10 Hz ... 2,000 Hz (EN 60068-2-6)

## Certificates

<b>EU declaration of conformity</b>	✓
<b>UK declaration of conformity</b>	✓
<b>ACMA declaration of conformity</b>	✓
<b>Moroccan declaration of conformity</b>	✓
<b>China RoHS</b>	✓
<b>cULus certificate</b>	✓
<b>Information according to Art. 3 of Data Act (Regulation EU 2023/2854)</b>	✓

## Classifications

<b>ECLASS 5.0</b>	27270501
-------------------	----------

<b>ECLASS 5.1.4</b>	27270501
<b>ECLASS 6.0</b>	27270590
<b>ECLASS 6.2</b>	27270590
<b>ECLASS 7.0</b>	27270501
<b>ECLASS 8.0</b>	27270501
<b>ECLASS 8.1</b>	27270501
<b>ECLASS 9.0</b>	27270501
<b>ECLASS 10.0</b>	27270501
<b>ECLASS 11.0</b>	27270501
<b>ECLASS 12.0</b>	27270501
<b>ETIM 5.0</b>	EC001486
<b>ETIM 6.0</b>	EC001486
<b>ETIM 7.0</b>	EC001486
<b>ETIM 8.0</b>	EC001486
<b>UNSPSC 16.0901</b>	41112113

### Dimensional drawing

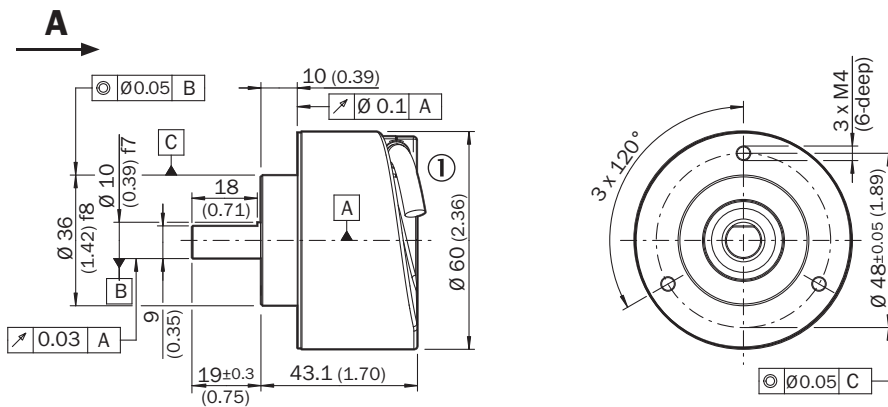

Dimensions in mm (inch)

① cable diameter = 5.6 mm +/- 0.2 mm bend radius = 30 mm

### PIN assignment

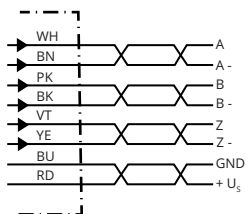

PIN Male connector M12, 8-pin	PIN Male connector M23, 12-pin	Wire colors (cable connection)	TTL/HTL signal	Sin/Cos 1.0 V <sub>PP</sub>	Explanation
1	6	Brown	A	COS-	Signal wire

PIN Male connector M12, 8-pin	PIN Male connector M23, 12-pin	Wire colors (cable connection)	TTL/HTL signal	Sin/Cos 1.0 V <sub>PP</sub>	Explanation
2	5	White	A	COS+	Signal wire
3	1	Black	$\bar{B}$	SIN-	Signal wire
4	8	Pink	B	SIN+	Signal wire
5	4	Yellow	$\bar{Z}$	$\bar{Z}$	Signal wire
6	3	Purple	Z	Z	Signal wire
7	10	Blue	GND	GND	Ground connection
8	12	Red	+U <sub>S</sub>	+U <sub>S</sub>	Supply voltage
-	9	-	N.c.	N.c.	Not assigned
-	2	-	N.c.	N.c.	Not assigned
-	11	-	N.c.	N.c.	Not assigned
-	7 <sup>1)</sup>	Orange	0-SET <sup>1)</sup>	N.c.	Set zero pulse <sup>1)</sup>
Screen	Screen	Screen	Screen	Screen	Screen connected to housing on encoder side. Connected to ground on control side.

<sup>1)</sup>For electrical interfaces only: M, U, V, W with 0-SET function on PIN 7 on M23 plug. The 0-SET input is used to set the zero pulse to the current shaft position. If the 0-SET input is applied to US for longer than 250 ms after it has previously been open or applied to GND for at least 1,000 ms, the current shaft position is assigned zero pulse signal "Z".

maximum revolution range

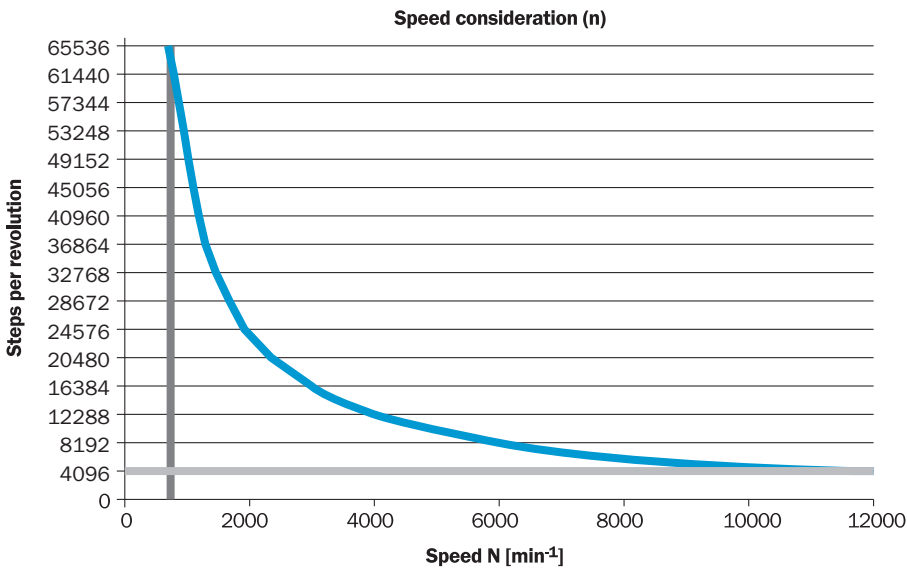

signal outputs

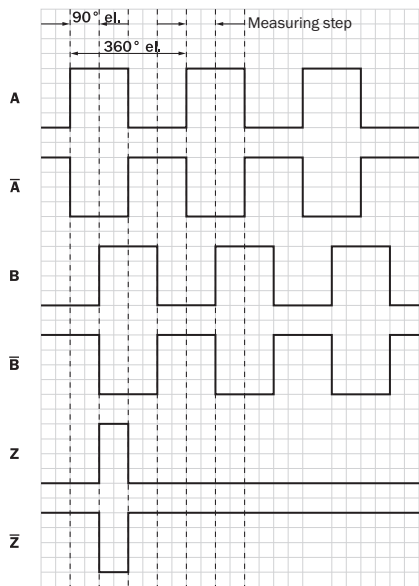











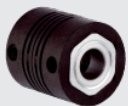



CW with view on the encoder shaft in direction "A", compare dimensional drawing.

Supply voltage	Output
4,5 V ... 5,5 V	TTL
10 V ... 32 V	TTL
10 V ... 32 V	HTL

## Recommended accessories





Other models and accessories → [www.sick.com/DFS60](http://www.sick.com/DFS60)

	Brief description	Type	part no.
shaft adaptation			
	<ul style="list-style-type: none"> <li><b>Product segment:</b> Shaft adaptation</li> <li><b>Product:</b> Shaft couplings</li> <li><b>Description:</b> Bellows coupling, shaft diameter 6 mm / 10 mm, maximum shaft offset: radial <math>\pm</math> 0.25 mm, axial <math>\pm</math> 0.4 mm, angular <math>\pm</math> 4°; max. speed 10,000 rpm, -30 °C to +120 °C, max. torque 120 Ncm; material: stainless steel bellows, aluminum hub</li> </ul>	KUP-0610-B	5312982
	<ul style="list-style-type: none"> <li><b>Product segment:</b> Shaft adaptation</li> <li><b>Product:</b> Shaft couplings</li> <li><b>Description:</b> Double loop coupling, shaft diameter 6 mm / 10 mm, max. shaft offset: radially <math>\pm</math> 2.5 mm, axially <math>\pm</math> 3 mm, angle <math>\pm</math> 10 degrees; max. speed 3.000 rpm, -30 to +80 degrees Celsius, torsional spring stiffness of 25 Nm/rad</li> </ul>	KUP-0610-D	5326697
	<ul style="list-style-type: none"> <li><b>Product segment:</b> Shaft adaptation</li> <li><b>Product:</b> Shaft couplings</li> <li><b>Description:</b> Spring washer coupling, shaft diameter 6 mm / 10 mm, Maximum shaft offset: radial <math>\pm</math> 0.3 mm, axial <math>\pm</math> 0.4 mm, angular <math>\pm</math> 2.5°; max. speed 12,000 rpm, -10° to +80 °C, max. torque 60 Ncm; material: aluminum flange, glass fiber-reinforced polyamide membrane and hardened steel coupling pin</li> </ul>	KUP-0610-F	5312985
	<ul style="list-style-type: none"> <li><b>Product segment:</b> Shaft adaptation</li> <li><b>Product:</b> Shaft couplings</li> <li><b>Description:</b> Bar coupling, shaft diameter 6 mm / 10 mm, max. shaft offset: radial <math>\pm</math> 0,3 mm, axial <math>\pm</math> 0,3 mm, angular <math>\pm</math> 3°; max. speed 10.000 rpm, -10° to +80 °C, max. torque: 80 Ncm, material: fiber-glass reinforced polyamide, aluminum hub</li> </ul>	KUP-0610-S	2056407
	<ul style="list-style-type: none"> <li><b>Product segment:</b> Shaft adaptation</li> <li><b>Product:</b> Shaft couplings</li> <li><b>Description:</b> Claw coupling, shaft diameter 6 mm / 10 mm, damping element 80 shore blue, maximum shaft offset: radial <math>\pm</math> 0.22 mm, axial <math>\pm</math> 1 mm angular <math>\pm</math> 1.3°, max. speed 19,000 rpm, angle of twist max. 10°, -30 °C to +80 °C, max. torque 800 Ncm, tightening torque of screws: ISO 4029 150 Ncm, material: aluminum flange, damping element: polyurethane</li> </ul>	KUP-0610-J	2127056
	<ul style="list-style-type: none"> <li><b>Product segment:</b> Shaft adaptation</li> <li><b>Product:</b> Shaft couplings</li> <li><b>Description:</b> Double loop coupling, shaft diameter 8 mm / 10 mm, max. shaft offset: radially <math>\pm</math> 0,25 mm, axially <math>\pm</math> 0,4 mm, angle <math>\pm</math> 4 degrees; max. speed 10.000 rpm, -30 to +120 degrees Celsius, torsional spring stiffness of 150 Nm/rad</li> </ul>	KUP-0810-D	5326704
	<ul style="list-style-type: none"> <li><b>Product segment:</b> Shaft adaptation</li> <li><b>Product:</b> Shaft couplings</li> <li><b>Description:</b> Bar coupling, shaft diameter 8 mm / 10 mm, max. shaft offset: radial <math>\pm</math> 0,3 mm, axial <math>\pm</math> 0,3 mm, angular <math>\pm</math> 3°; max. speed 10.000 rpm, -10° to +80 °C, max. torque: 80 Ncm, material: fiber-glass reinforced polyamide, aluminum hub</li> </ul>	KUP-0810-S	5314178
	<ul style="list-style-type: none"> <li><b>Product segment:</b> Shaft adaptation</li> <li><b>Product:</b> Shaft couplings</li> <li><b>Description:</b> Bellows coupling, shaft diameter 10 mm/10 mm; maximum shaft offset: radial <math>\pm</math> 0.25 mm, axial <math>\pm</math> 0.4 mm, angular <math>\pm</math> 4°; max. revolutions 10,000 rpm, -30° to +120 °C, max. torque 120 Ncm; material: stainless steel bellows, aluminum clamping hubs</li> </ul>	KUP-1010-B	5312983
	<ul style="list-style-type: none"> <li><b>Product segment:</b> Shaft adaptation</li> <li><b>Product:</b> Shaft couplings</li> <li><b>Description:</b> Double loop coupling, shaft diameter 10 mm / 10 mm, Maximum shaft offset: radial <math>\pm</math> 2.5 mm, axial <math>\pm</math> 3 mm, angular <math>\pm</math> 10°; max. speed 3,000 rpm, -30° to +80 °C, max. torque 1.5 Nm; material: polyurethane, galvanized steel flange</li> </ul>	KUP-1010-D	5326703
	<ul style="list-style-type: none"> <li><b>Product segment:</b> Shaft adaptation</li> <li><b>Product:</b> Shaft couplings</li> <li><b>Description:</b> Spring washer coupling, shaft diameter 10 mm / 10 mm, maximum shaft offset, radial <math>\pm</math> 0.3 mm, axial <math>\pm</math> 0.4 mm, angle <math>\pm</math> 2.5°, torsion spring stiffness 30 Nm/rad; material: aluminum flange, glass-fiber reinforced polyamide membrane and hardened steel coupling pin</li> </ul>	KUP-1010-F	5312986
	<ul style="list-style-type: none"> <li><b>Product segment:</b> Shaft adaptation</li> <li><b>Product:</b> Shaft couplings</li> <li><b>Description:</b> Bar coupling, shaft diameter 10 mm / 10 mm; maximum shaft offset: radial <math>\pm</math> 0.3 mm, axial <math>\pm</math> 0.2 mm, angular <math>\pm</math> 3°; speed 10,000 rpm, -10° to +80° Celsius, max. torque 80 Ncm; material: glass fiber-reinforced polyamide, aluminum hub</li> </ul>	KUP-1010-S	2056408
	<ul style="list-style-type: none"> <li><b>Product segment:</b> Shaft adaptation</li> <li><b>Product:</b> Shaft couplings</li> </ul>	KUP-1012-B	5312984

	Brief description	Type	part no.
	<ul style="list-style-type: none"> <li><b>Description:</b> 10 mm / 12 mm; maximum shaft offset: radial +/- 0.25 mm, axial +/- 0.4 mm, angular +/- 4°; max. revolutions 10,000 rpm, -30° to +120 °C, max. torque 120 Ncm; material: stainless steel bellows, aluminum clamping hubs</li> </ul>	KUP-1012-D	5326702
	<ul style="list-style-type: none"> <li><b>Product segment:</b> Shaft adaptation</li> <li><b>Product:</b> Shaft couplings</li> <li><b>Description:</b> Double loop coupling, shaft diameter 10 mm / 12 mm, Maximum shaft offset: radial +/- 2.5 mm, axial +/- 3 mm, angular +/- 10°; max. speed 3,000 rpm, -30° to +80 °C, max. torque 1.5 Nm; material: polyurethane, galvanized steel flange</li> </ul>	KUP-0810-J	2128267
	<ul style="list-style-type: none"> <li><b>Product segment:</b> Shaft adaptation</li> <li><b>Product:</b> Shaft couplings</li> <li><b>Description:</b> Claw coupling, shaft diameter 8 mm / 10 mm, damping element 80 shore blue, maximum shaft offset: radial ± 0.22 mm, axial ± 1 mm angular ± 1.3°, max. speed 19,000 rpm, angle of twist max. 10°, -30 °C to +80 °C, max. torque 800 Ncm, tightening torque of screws: ISO 4029 150 Ncm, material: aluminum flange, damping element: polyurethane</li> </ul>	KUP-1010-J	2127054
	<ul style="list-style-type: none"> <li><b>Product segment:</b> Shaft adaptation</li> <li><b>Product:</b> Shaft couplings</li> <li><b>Description:</b> Claw coupling, shaft diameter 10 mm / 10 mm, damping element 80 shore blue, maximum shaft offset: radial ± 0.22 mm, axial ± 1 mm angular ± 1.3°, max. speed 19,000 rpm, angle of twist max. 10°, -30 °C to +80 °C, max. torque 800 Ncm, tightening torque of screws: ISO 4029 150 Ncm, material: aluminum flange, damping element: polyurethane</li> </ul>	KUP-1012-J	2128265



	Brief description	Type	part no.
measuring wheels and measuring wheel mechanics			
	<ul style="list-style-type: none"> <li><b>Product segment:</b> Measuring wheels and measuring wheel mechanics</li> <li><b>Product family:</b> Measuring wheels</li> <li><b>Description:</b> Aluminum measuring wheel with studded polyurethane surface for 6 mm solid shaft, circumference 200 mm</li> </ul>	BEF-MR06200APN	4084747
	<ul style="list-style-type: none"> <li><b>Product segment:</b> Measuring wheels and measuring wheel mechanics</li> <li><b>Product family:</b> Measuring wheel mechanics</li> <li><b>Description:</b> SICK modular measuring wheel system for face mount flange encoder with S4 mechanical design (10 mm x 19 mm solid shaft), e.g., DFS60-S4: with O-ring measuring wheel, circumference 200 mm</li> <li><b>Suitable for:</b> Face mount flange encoder DFS60, DBS60, AFM60, AFS60, mechanical design S4 (solid shaft 10 mm x 19 mm)</li> </ul>	BEF-MRS-10-U	2085714
	<ul style="list-style-type: none"> <li><b>Product segment:</b> Measuring wheels and measuring wheel mechanics</li> <li><b>Product family:</b> Measuring wheels</li> <li><b>Description:</b> Aluminium measuring wheel with O-ring (NBR70) for 10 mm solid shaft, circumference 200 mm</li> </ul>	BEF-MR010020R	2055224
	<ul style="list-style-type: none"> <li><b>Product segment:</b> Measuring wheels and measuring wheel mechanics</li> <li><b>Product family:</b> Measuring wheels</li> <li><b>Description:</b> Aluminium measuring wheel with O-ring (NBR70) for 10 mm solid shaft, circumference 300 mm</li> </ul>	BEF-MR010030R	2049278
	<ul style="list-style-type: none"> <li><b>Product segment:</b> Measuring wheels and measuring wheel mechanics</li> <li><b>Product family:</b> Measuring wheels</li> <li><b>Description:</b> Measuring wheel with O-ring (NBR70) for 10 mm solid shaft, circumference 500 mm</li> </ul>	BEF-MR010050R	2055227
	<ul style="list-style-type: none"> <li><b>Product segment:</b> Measuring wheels and measuring wheel mechanics</li> <li><b>Product family:</b> Measuring wheels</li> <li><b>Description:</b> Aluminum measuring wheel with cross-knurled surface for 10 mm solid shaft, circumference 200 mm</li> </ul>	BEF-MR10200AK	4084737
	<ul style="list-style-type: none"> <li><b>Product segment:</b> Measuring wheels and measuring wheel mechanics</li> <li><b>Product family:</b> Measuring wheels</li> <li><b>Description:</b> Aluminum measuring wheel with smooth polyurethane surface for 10 mm solid shaft, circumference 200 mm</li> </ul>	BEF-MR10200AP	4084738
	<ul style="list-style-type: none"> <li><b>Product segment:</b> Measuring wheels and measuring wheel mechanics</li> <li><b>Product family:</b> Measuring wheels</li> </ul>	BEF-MR10200APN	4084739

	Brief description	Type	part no.
	<ul style="list-style-type: none"> <li><b>Description:</b> Aluminum measuring wheel with studded polyurethane surface for 10 mm solid shaft, circumference 200 mm</li> </ul>		
	<ul style="list-style-type: none"> <li><b>Product segment:</b> Measuring wheels and measuring wheel mechanics</li> <li><b>Product family:</b> Measuring wheels</li> <li><b>Description:</b> Aluminum measuring wheel with cross-knurled surface for 10 mm solid shaft, circumference 500 mm</li> </ul>	BEF-MR10500AK	4084733
	<ul style="list-style-type: none"> <li><b>Product segment:</b> Measuring wheels and measuring wheel mechanics</li> <li><b>Product family:</b> Measuring wheels</li> <li><b>Description:</b> Aluminum measuring wheel with smooth polyurethane surface for 10 mm solid shaft, circumference 500 mm</li> </ul>	BEF-MR10500AP	4084734
	<ul style="list-style-type: none"> <li><b>Product segment:</b> Measuring wheels and measuring wheel mechanics</li> <li><b>Product family:</b> Measuring wheels</li> <li><b>Description:</b> Aluminum measuring wheel with ridged polyurethane surface for 10 mm solid shaft, circumference 500 mm</li> </ul>	BEF-MR10500APG	4084736
	<ul style="list-style-type: none"> <li><b>Product segment:</b> Measuring wheels and measuring wheel mechanics</li> <li><b>Product family:</b> Measuring wheels</li> <li><b>Description:</b> Aluminum measuring wheel with studded polyurethane surface for 10 mm solid shaft, circumference 500 mm</li> </ul>	BEF-MR10500APN	4084735

	Brief description	Type	part no.
Mounting systems			
	<ul style="list-style-type: none"> <li><b>Description:</b> Bearing block for servo and face mount flange encoder. The heavy-duty bearing block is used to absorb very large radial and axial shaft loads. Particularly when using belt pulleys, chain sprockets, friction wheels. Operating speed max. 4,000 rpm<sup>-1</sup>, axial shaft load 150 N, radial shaft load 250 N, bearing service life 3.6 x 10<sup>9</sup> revolutions</li> </ul>	BEF-FA-LB1210	2044591
	<ul style="list-style-type: none"> <li><b>Description:</b> Mounting bracket for encoder with spigot 36 mm for face mount flange</li> <li><b>Items supplied:</b> Mounting kit included</li> </ul>	BEF-WF-36	2029164
	<ul style="list-style-type: none"> <li><b>Description:</b> Flange adapter, adaptation of face mount flange with 36 mm centering hub to 50 mm servo flange, aluminum, including 3 flat head screws M4 x 10</li> <li><b>Material:</b> Aluminum</li> <li><b>Details:</b> Aluminum</li> <li><b>Items supplied:</b> Including 3 countersunk screws M3 x 10</li> </ul>	BEF-FA-036-050	2029160
	<ul style="list-style-type: none"> <li><b>Description:</b> Flange adapter, adaptation of face mount flange with 36 mm centering hub to 60 mm square mounting plate, aluminum, including 3 flat head screws M4 x 8</li> <li><b>Material:</b> Aluminum</li> <li><b>Details:</b> Aluminum</li> <li><b>Items supplied:</b> Including 3 countersunk screws M4 x 8</li> </ul>	BEF-FA-036-060REC	2029162
	<ul style="list-style-type: none"> <li><b>Description:</b> Flange adapter, adaptation of face mount flange with 36 mm centering hub to 58 mm square mounting plate with shock absorbers, aluminum</li> <li><b>Material:</b> Aluminum</li> <li><b>Details:</b> Aluminum</li> </ul>	BEF-FA-036-060RSA	2029163
	<ul style="list-style-type: none"> <li><b>Description:</b> Flange adapter, adaptation of face mount flange with 36 mm centering hub to 63 mm square mounting plate, aluminum, including 3 flat head screws M4 x 8</li> <li><b>Material:</b> Aluminum</li> <li><b>Details:</b> Aluminum</li> <li><b>Items supplied:</b> Including 3 countersunk screws M4 x 8</li> </ul>	BEF-FA-036-063REC	2034225
	<ul style="list-style-type: none"> <li><b>Description:</b> Flange adapter, adaptation of face mount flange with 36 mm centering hub to 100 mm servo flange with 60 mm centering hub, aluminum</li> <li><b>Material:</b> Aluminum</li> <li><b>Details:</b> Aluminum</li> </ul>	BEF-FA-036-100	2029161
	<ul style="list-style-type: none"> <li><b>Description:</b> Flange adapter (adapts size 60 face mount flange encoder to bearing block with part. no. 2044591)</li> </ul>	BEF-FA-036-050-019	2063378
	<ul style="list-style-type: none"> <li><b>Description:</b> Mounting angle spring-loaded, for flange with centerring collar 36 mm, working temperature range -40° ... +120° C</li> <li><b>Material:</b> Aluminum</li> <li><b>Details:</b> Aluminum</li> </ul>	BEF-WF36F	4084775

	Brief description	Type	part no.
connectors and cables			
	<ul style="list-style-type: none"> <li>• <b>Connection type head A:</b> Male connector, M12, 8-pin, straight, A-coded</li> <li>• <b>Signal type:</b> Incremental</li> <li>• <b>Cable:</b> CAT5, CAT5e</li> <li>• <b>Description:</b> Incremental, shielded</li> <li>• <b>Connection systems:</b> IDC quick connection</li> <li>• <b>Permitted cross-section:</b> 0.14 mm<sup>2</sup> ... 0.34 mm<sup>2</sup></li> </ul>	STE-1208-GA01	6044892
	<ul style="list-style-type: none"> <li>• <b>Connection type head A:</b> Female connector, JST, 8-pin, straight</li> <li>• <b>Connection type head B:</b> Flying leads</li> <li>• <b>Signal type:</b> SSI, Incremental</li> <li>• <b>Items supplied:</b> JST including sealing</li> <li>• <b>Cable:</b> 3 m, 8-wire, PUR, halogen-free</li> <li>• <b>Description:</b> SSI, shielded, Incremental</li> </ul>	DOL-0J08-G3M0AA6	2048591
	<ul style="list-style-type: none"> <li>• <b>Connection type head A:</b> Female connector, JST, 8-pin, straight</li> <li>• <b>Connection type head B:</b> Flying leads</li> <li>• <b>Signal type:</b> SSI, Incremental</li> <li>• <b>Items supplied:</b> JST including sealing</li> <li>• <b>Cable:</b> 1.5 m, 8-wire, PUR, halogen-free</li> <li>• <b>Description:</b> SSI, shielded, Incremental</li> </ul>	DOL-0J08-G1M5AA6	2048590
	<ul style="list-style-type: none"> <li>• <b>Connection type head A:</b> Female connector, JST, 8-pin, straight</li> <li>• <b>Connection type head B:</b> Flying leads</li> <li>• <b>Signal type:</b> Incremental, SSI</li> <li>• <b>Items supplied:</b> JST including sealing</li> <li>• <b>Cable:</b> 0.5 m, 8-wire, PUR, halogen-free</li> <li>• <b>Description:</b> Incremental, shielded, SSI</li> </ul>	DOL-0J08-G0M5AA3	2046873
	<ul style="list-style-type: none"> <li>• <b>Connection type head A:</b> Female connector, JST, 8-pin, straight</li> <li>• <b>Connection type head B:</b> Flying leads</li> <li>• <b>Signal type:</b> Incremental, SSI</li> <li>• <b>Items supplied:</b> JST including sealing</li> <li>• <b>Cable:</b> 5 m, 8-wire, PUR, halogen-free</li> <li>• <b>Description:</b> Incremental, shielded, SSI</li> </ul>	DOL-0J08-G05MAA3	2046876
	<ul style="list-style-type: none"> <li>• <b>Connection type head A:</b> Female connector, JST, 8-pin, straight</li> <li>• <b>Connection type head B:</b> Flying leads</li> <li>• <b>Signal type:</b> Incremental, SSI</li> <li>• <b>Items supplied:</b> JST including sealing</li> <li>• <b>Cable:</b> 10 m, 8-wire, PUR, halogen-free</li> <li>• <b>Description:</b> Incremental, shielded, SSI</li> </ul>	DOL-0J08-G10MAA3	2046877
	<ul style="list-style-type: none"> <li>• <b>Connection type head A:</b> Male connector, M23, 12-pin, straight, A-coded</li> <li>• <b>Signal type:</b> HIPERFACE<sup>®</sup>, SSI, Incremental</li> <li>• <b>Description:</b> HIPERFACE<sup>®</sup>, shieldedSSIIncremental</li> <li>• <b>Connection systems:</b> Solder connection</li> </ul>	STE-2312-GX	6028548
	<ul style="list-style-type: none"> <li>• <b>Connection type head A:</b> Male connector, M23, 12-pin, straight, A-coded</li> <li>• <b>Signal type:</b> HIPERFACE<sup>®</sup>, SSI, Incremental</li> <li>• <b>Description:</b> HIPERFACE<sup>®</sup>, shieldedSSIIncremental</li> <li>• <b>Connection systems:</b> Solder connection</li> </ul>	STE-2312-G01	2077273
	<ul style="list-style-type: none"> <li>• <b>Connection type head A:</b> Female connector, JST, 8-pin, straight</li> <li>• <b>Connection type head B:</b> Male connector, M23, 12-pin, straight</li> <li>• <b>Signal type:</b> Incremental</li> <li>• <b>Cable:</b> 0.35 m, 8-wire, PUR, halogen-free</li> <li>• <b>Description:</b> Incremental, shielded</li> </ul>	STL-2312-GM35AA3	2061621
	<ul style="list-style-type: none"> <li>• <b>Connection type head A:</b> Female connector, JST, 8-pin, straight</li> <li>• <b>Connection type head B:</b> Male connector, M23, 12-pin, straight</li> <li>• <b>Signal type:</b> Incremental</li> <li>• <b>Cable:</b> 1 m, 8-wire, PUR, halogen-free</li> <li>• <b>Description:</b> Incremental, shielded</li> </ul>	STL-2312-G01MAA3	2061622
	<ul style="list-style-type: none"> <li>• <b>Connection type head A:</b> Female connector, JST, 8-pin, straight</li> <li>• <b>Connection type head B:</b> Male connector, M23, 12-pin, straight</li> <li>• <b>Signal type:</b> Incremental</li> <li>• <b>Cable:</b> 2 m, 8-wire, PUR, halogen-free</li> <li>• <b>Description:</b> Incremental, shielded</li> </ul>	STL-2312-G02MAA3	2061504

## SICK AT A GLANCE

SICK is one of the leading manufacturers of intelligent sensors and sensor solutions for industrial applications. A unique range of products and services creates the perfect basis for controlling processes securely and efficiently, protecting individuals from accidents and preventing damage to the environment.

We have extensive experience in a wide range of industries and understand their processes and requirements. With intelligent sensors, we can deliver exactly what our customers need. In application centers in Europe, Asia and North America, system solutions are tested and optimized in accordance with customer specifications. All this makes us a reliable supplier and development partner.

Comprehensive services complete our offering: SICK LifeTime Services provide support throughout the machine life cycle and ensure safety and productivity.

For us, that is “Sensor Intelligence.”

## WORLDWIDE PRESENCE:

Contacts and other locations –[www.sick.com](http://www.sick.com)