

OD5-85T20

OD Precision

DISPLACEMENT MEASUREMENT SENSORS

SICK
Sensor Intelligence.



Ordering information

Type	part no.
OD5-85T20	6035979

Other models and accessories → www.sick.com/OD_Precision



Detailed technical data

Features

System part	Sensor head
Measuring range	65 mm ... 105 mm ^{1) 2)}
Target	Natural objects
Repeatability	1 µm ³⁾
Linearity	Diffuse ± 20 µm ³⁾ Specular ± 16 µm ³⁾
Response time	≥ 0.1 ms ^{4) 5)}
Output time	≥ 0.1 ms
Light source	Laser, red visible red light
Type of light	Visible red light
Laser class	2 (IEC 60825-1:2014, EN 60825-1:2014) ⁶⁾
Typ. light spot size (distance)	70 µm x 290 µm (85 mm)
Special task	Thickness measurement of transparent material
Additional function	Mean-value setting 1 ... 4,096x Selectable measuring frequency (automatic / 0.1 ms ... 3.2 ms) Automatic sensitivity adjustment Manual sensitivity adjustment Mutual interference Glass thickness measurement
Thickness measurement of transparent material	2 mm ... 20 mm
General notes	Note on use OD Precision sensor head can be used in combination with AOD5-P/N1 or stand-alone via RS-422
Safety-related parameters	

¹⁾ 6 % ... 90 % remission; at default settings.

²⁾ If there are reflections, the measuring range is reduced to 72.3 mm ... 92.3 mm.

³⁾ Measurement at 90% remission (ceramic, white), or mirror for OD5-25x; averaging set to: 256 or 4096 for OD5-25x; constant ambient conditions.

⁴⁾ Time needed for automatic sensitivity adjustment is calculated as: sampling period x 20. At default setting 100 µs (10kHz) this is ≤ 2ms.

⁵⁾ Default setting for OD5-350x100 and OD5-500x200 = 0.8 ms, or 1.25 kHz, all others = 0.1 ms/10 kHz.

⁶⁾ Wavelength: 658 nm, max. output: 1 mW.

MTTF _D	101 years
DC _{avg}	0%

- 1) 6 % ... 90 % remission; at default settings.
- 2) If there are reflections, the measuring range is reduced to 72.3 mm ... 92.3 mm.
- 3) Measurement at 90% remission (ceramic, white), or mirror for OD5-25x; averaging set to: 256 or 4096 for OD5-25x; constant ambient conditions.
- 4) Time needed for automatic sensitivity adjustment is calculated as: sampling period x 20. At default setting 100 μs (10kHz) this is <= 2ms.
- 5) Default setting for OD5-350x100 and OD5-500x200 = 0.8 ms, or 1.25 kHz, all others = 0.1 ms/10 kHz.
- 6) Wavelength: 658 nm, max. output: 1 mW.

Interfaces

Serial	✓, RS-422
Remark	RS-232 optional via external evaluation unit AOD5
Digital output	
Number	5 ¹⁾
Type	PNP / NPN
Maximum output current I _A	≤ 100 mA
Analog output	
Number	3 ^{1) 2)}
Type	Current output / voltage output
Current	4 mA ... 20 mA, ≤ 300 Ω
Voltage	0 V ... 10 V ³⁾
Laser-off input	1 x laser-off

- 1) Optional over evaluation unit AOD5.
- 2) A maximum of three current and three voltage outputs are possible via the AOD5 evaluation unit.
- 3) Output resistance 100 Ω, min. load 10 k Ω.

Electronics

Supply voltage U_B	DC 12 V ... 24 V ¹⁾
Warm-up time	≤ 5 min
Indication	LEDs, 4" color display on optional evaluation unit
Enclosure rating	IP67
Protection class	III

- 1) DC 12 V (-5 %) ... DC 24 V (+10 %).

Mechanics

Dimensions (W x H x D)	29 mm x 78 mm x 75 mm
Housing material	Metal (Aluminum)
Window material	Glass
Weight	250 g ¹⁾
Connection type	0.5 m cable with connector ²⁾

- 1) Includes 0.5 m cable.
- 2) Can be extended to up to 50 m with extension cable.

Ambient data

Ambient temperature, operation	-10 °C ... +50 °C
---------------------------------------	-------------------

Ambient temperature, storage	-20 °C ... +60 °C
Relative air humidity (non-condensing)	35 % ... 85 %
Temperature drift	± 0.01 % FS/K (FS = Full Scale = Measuring range of sensor)
Typ. Ambient light immunity	Artificial light: ≤ 3,000 lx Sunlight: ≤ 10,000 lx
Vibration resistance	10 Hz ... 55 Hz (amplitude 1.5 mm, x-, y-, z-axis 2 hours each)
Shock resistance	50 G (x, y, z axis 3 times each)

Certificates

EU declaration of conformity	✓
UK declaration of conformity	✓
ACMA declaration of conformity	✓
Moroccan declaration of conformity	✓
China RoHS	✓
Information according to Art. 3 of Data Act (Regulation EU 2023/2854)	✓

Classifications

ECLASS 5.0	27270801
ECLASS 5.1.4	27270801
ECLASS 6.0	27270801
ECLASS 6.2	27270801
ECLASS 7.0	27270801
ECLASS 8.0	27270801
ECLASS 8.1	27270801
ECLASS 9.0	27270801
ECLASS 10.0	27270801
ECLASS 11.0	27270801
ECLASS 12.0	27270916
ETIM 5.0	EC001825
ETIM 6.0	EC001825
ETIM 7.0	EC001825
ETIM 8.0	EC001825
UNSPSC 16.0901	41111613

Dimensional drawing OD5-85xxx

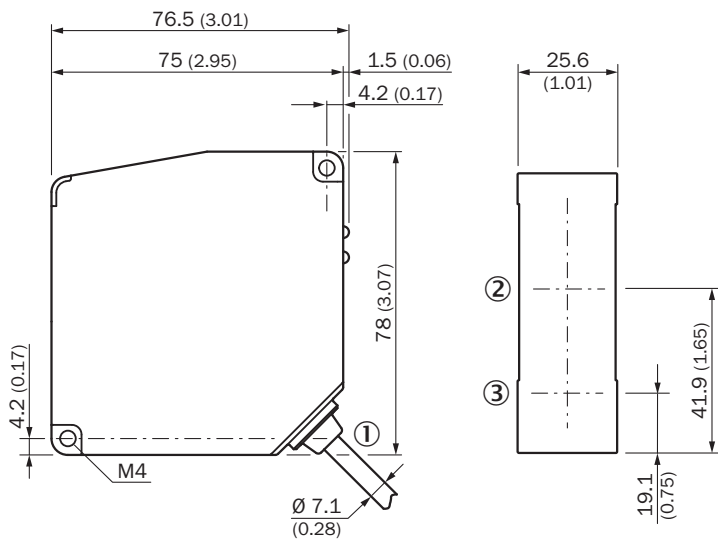

Dimensions in mm (inch)

- ① Cable Ø 7.1 mm, 0.5 m with connector, 12-pin
- ② optical axis, receiver
- ③ optical axis, sender

Connection type Hirose 12-pin male connector for sensor head



Connection diagram

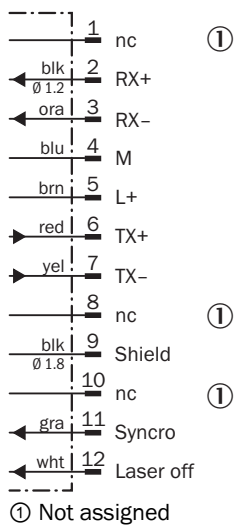

Adjustment possible

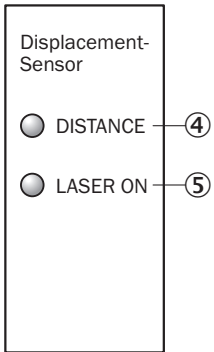

- ④ Distance indicator
- ⑤ Status indicator laser (laser on)

Light spot size OD5-85T20

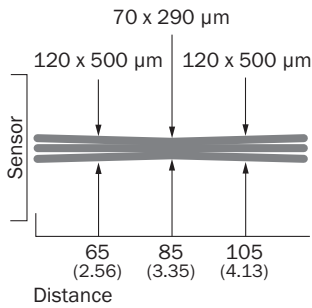

All dimensions in mm (inch)

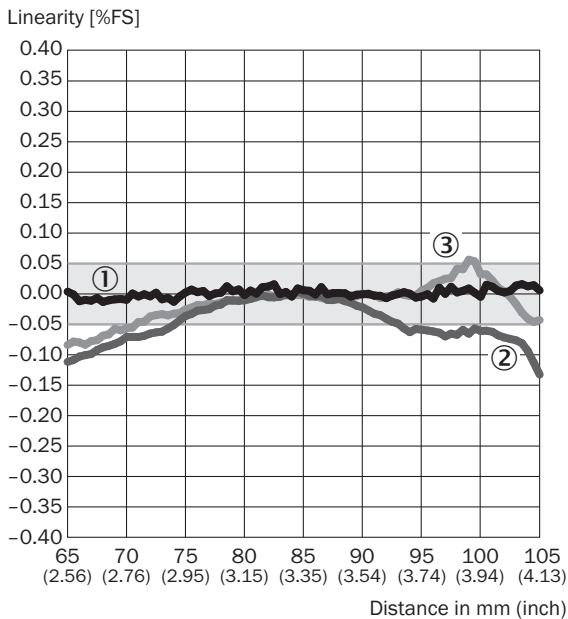

Linearity OD5-85T20



- ① White ceramic
- ② stainless steel
- ③ black rubber

Recommended accessories

Other models and accessories → www.sick.com/OD_Precision

	Brief description	Type	part no.
connectors and cables			
	<ul style="list-style-type: none"> • Connection type head A: Female connector, M12, 12-pin, straight • Connection type head B: Male connector, M12, 12-pin, straight • Signal type: RS-422 • Cable: 2 m, 12-wire, twisted pair, PVC • Description: RS-422, shielded • Note: OD Precision specific 	YFHRSB-020XXXMRSE	6035986
	<ul style="list-style-type: none"> • Connection type head A: Female connector, M12, 12-pin, straight • Connection type head B: Flying leads • Cable: 5 m, 12-wire, PVC • Description: Shielded • Note: For stand-alone operation 	DOL-1212-G05M	6035988
	<ul style="list-style-type: none"> • Connection type head A: Female connector, M12, 12-pin, straight • Connection type head B: Male connector, M12, 12-pin, straight • Signal type: RS-422 • Cable: 5 m, 12-wire, twisted pair, PVC • Description: RS-422, shielded • Note: OD Precision specific 	YFHRSB-050XXXMRSE	6035987
	<ul style="list-style-type: none"> • Connection type head A: Male connector, 50-pin, straight • Connection type head B: Flying leads • Cable: 3 m, 50-wire, PVC • Description: Shielded • Connection systems: Flying leads • Note: In- and output expansion cable for AOD5-P/N1 (OD Precision) 	IO-EXP-AOD5	6035990
	<ul style="list-style-type: none"> • Connection type head A: Male connector, 12-pin • Connection type head B: Terminal connector, 12-pin • Description: Unshielded • Connection systems: Spring terminal • Note: Terminal strip for AOD5-P/N1 (OD Precision) 	TERM.-AOD5	6035989
integration modules and adapters			
	<ul style="list-style-type: none"> • Description: Evaluation unit: OD Precision, 5 x PNP 	AOD5-P1	6035985
	<ul style="list-style-type: none"> • Description: Evaluation unit: OD Precision, 5 x NPN 	AOD5-N1	6035984

SICK AT A GLANCE

SICK is one of the leading manufacturers of intelligent sensors and sensor solutions for industrial applications. A unique range of products and services creates the perfect basis for controlling processes securely and efficiently, protecting individuals from accidents and preventing damage to the environment.

We have extensive experience in a wide range of industries and understand their processes and requirements. With intelligent sensors, we can deliver exactly what our customers need. In application centers in Europe, Asia and North America, system solutions are tested and optimized in accordance with customer specifications. All this makes us a reliable supplier and development partner.

Comprehensive services complete our offering: SICK LifeTime Services provide support throughout the machine life cycle and ensure safety and productivity.

For us, that is “Sensor Intelligence.”

WORLDWIDE PRESENCE:

Contacts and other locations –www.sick.com