



UM18-211127112

UM18

ULTRASONIC DISTANCE SENSORS

**SICK**  
Sensor Intelligence.



### Ordering information

Type	part no.
UM18-211127112	6048395

Other models and accessories → [www.sick.com/UM18](http://www.sick.com/UM18)



### Detailed technical data

#### Features

<b>Operating range, limiting range</b>	30 mm ... 250 mm, 350 mm
<b>Target</b>	Natural objects
<b>Resolution</b>	≥ 0.069 mm
<b>Repeatability</b>	± 0.15 % <sup>1)</sup>
<b>Measurement accuracy</b>	± 1 % <sup>2) 3)</sup>
<b>Temperature compensation</b>	✓
<b>Response time</b>	32 ms <sup>4)</sup>
<b>Output time</b>	8 ms
<b>Ultrasonic frequency (typical)</b>	320 kHz
<b>Additional function</b>	Teach-in of analog output, Invertable analog output, multifunctional input: external teach / synchronization / multiplexing, synchronization of up to 20 sensors, multiplexing: no cross talk of up to 20 sensors, reset to factory default
<b>Safety-related parameters</b>	
	MTTF <sub>D</sub> 101 years
	DC <sub>avg</sub> 0%

<sup>1)</sup> In relation to the current measured value, minimum value ≥ resolution.

<sup>2)</sup> Referring to current measurement value.

<sup>3)</sup> Temperature compensation can be switched off, without temperature compensation: 0.17 % / K.

<sup>4)</sup> Subsequent smoothing of the analog output, depending on the application, may increase the response time by up to 200 %.

#### Interfaces

<b>Analog output</b>		
	Number	1
	Type	Voltage output
	Voltage	0 V ... 10 V, ≥ 100,000 Ω
	Resolution	12 bit
<b>Multifunctional input (MF)</b>		1 x MF

## Electronics

<b>Supply voltage <math>U_B</math></b>	DC 15 V ... 30 V <sup>1)</sup>
<b>Power consumption</b>	$\leq 1.2$ W <sup>2)</sup>
<b>Initialization time</b>	< 300 ms
<b>Display</b>	2 x LED
<b>Enclosure rating</b>	IP65 / IP67
<b>Protection class</b>	III

<sup>1)</sup> Limit values, reverse-polarity protected Operation in short-circuit protected network: max. 8 A, class 2.

<sup>2)</sup> Without load.

## Mechanics

<b>Dimensions (W x H x D)</b>	18 mm x 18 mm x 68.7 mm
<b>Design</b>	Cylindrical
<b>Sending axis</b>	Angled
<b>Housing material</b>	Metal (nickel-plated brass, ultrasonic transducer: polyurethane foam, glass epoxy resin)
<b>Weight</b>	30 g
<b>Thread size</b>	M18 x 1
<b>Connection type</b>	Male connector, M12, 5-pin

## Ambient data

<b>Ambient temperature, operation</b>	-25 °C ... +70 °C
<b>Ambient temperature, storage</b>	-40 °C ... +85 °C

## Certificates

<b>EU declaration of conformity</b>	✓
<b>UK declaration of conformity</b>	✓
<b>ACMA declaration of conformity</b>	✓
<b>Moroccan declaration of conformity</b>	✓
<b>China-RoHS</b>	✓
<b>cULus certificate</b>	✓

## Classifications

<b>ECLASS 5.0</b>	27270804
<b>ECLASS 5.1.4</b>	27270804
<b>ECLASS 6.0</b>	27270804
<b>ECLASS 6.2</b>	27270804
<b>ECLASS 7.0</b>	27270804
<b>ECLASS 8.0</b>	27270804
<b>ECLASS 8.1</b>	27270804
<b>ECLASS 9.0</b>	27270804
<b>ECLASS 10.0</b>	27270804
<b>ECLASS 11.0</b>	27270804
<b>ECLASS 12.0</b>	27272806
<b>ETIM 5.0</b>	EC001846

<b>ETIM 6.0</b>	EC001846
<b>ETIM 7.0</b>	EC001846
<b>ETIM 8.0</b>	EC001846
<b>UNSPSC 16.0901</b>	41111960

Dimensional drawing UM18-2xxxxx2

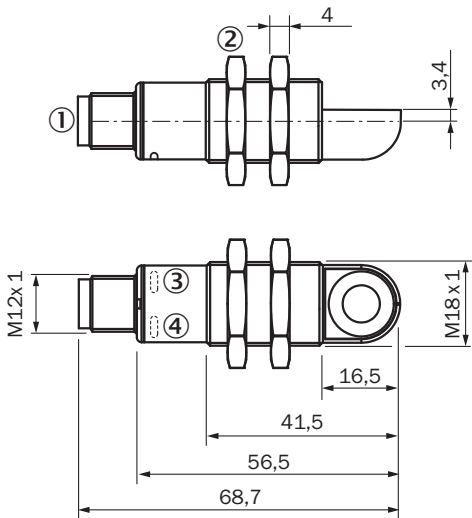

Dimensions in mm (inch)

- ① Connection
- ② Fixing nuts, width 24 mm
- ③ Status display for supply voltage active (green)
- ④ Status indicator switching/analog output (orange)

Connection type

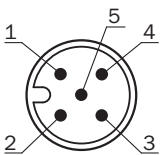

Connection diagram UM18-21xxx6xxx UM18-21xxx7xxx Connector M12, 5-pin

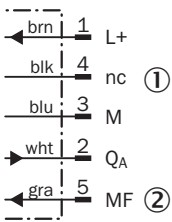

- ① Not assigned
- ② multifunctional input/synchronization and multiplex operation/communication Connect+

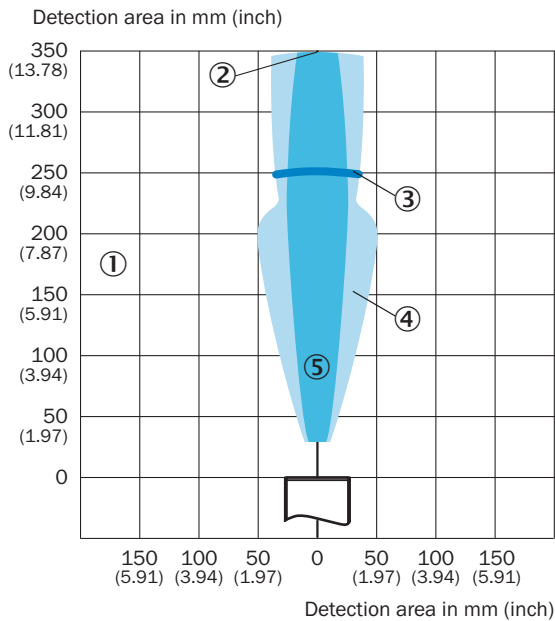

## Detection area UM18-211





- ① Detection range dependent on reflection properties, size, and alignment of the object
- ② Limiting range
- ③ operating range
- ④ example object: aligned plate 500 mm x 500 mm
- ⑤ Example object: cylindrical bar with a diameter of 10 mm

## Recommended accessories

Other models and accessories → [www.sick.com/UM18](http://www.sick.com/UM18)

	Brief description	Type	part no.
programming devices			
	<ul style="list-style-type: none"> <li>• <b>Product segment:</b> Integration modules and adapters</li> <li>• <b>Product family:</b> Cloning modules</li> <li>• <b>Description:</b> Tool for visualization, configuration and cloning, 3-digit LED display, supply voltage: DV 9 V ... 30 V</li> </ul>	Connect+ adapter (CPA)	6037782
Mounting systems			
	<ul style="list-style-type: none"> <li>• <b>Description:</b> Mounting plate for M18 sensors</li> <li>• <b>Material:</b> Steel</li> <li>• <b>Details:</b> Steel, zinc coated</li> <li>• <b>Items supplied:</b> Without mounting hardware</li> <li>• <b>Suitable for:</b> GR18, V180-2, V18, W15, Z1, Z2</li> </ul>	BEF-WG-M18	5321870
reflectors and optics			
		USP-UM18	5323658

	Brief description	Type	part no.
connectors and cables			
	<ul style="list-style-type: none"> <li>• <b>Connection type head A:</b> Female connector, M12, 5-pin, straight, A-coded</li> <li>• <b>Connection type head B:</b> Flying leads</li> <li>• <b>Signal type:</b> Sensor/actuator cable</li> <li>• <b>Cable:</b> 2 m, 5-wire, PVC</li> <li>• <b>Description:</b> Sensor/actuator cable, unshielded</li> <li>• <b>Application:</b> Zones with chemicals, Uncontaminated zones</li> </ul>	YF2A15-020VB5XLEAX	2096239
	<ul style="list-style-type: none"> <li>• <b>Connection type head A:</b> Female connector, M12, 5-pin, straight, A-coded</li> <li>• <b>Connection type head B:</b> Flying leads</li> <li>• <b>Signal type:</b> Sensor/actuator cable</li> <li>• <b>Cable:</b> 0.6 m, 5-wire, PVC</li> <li>• <b>Description:</b> Sensor/actuator cable, unshielded</li> <li>• <b>Application:</b> Zones with chemicals, Uncontaminated zones</li> </ul>	YF2A15-C60VB5XLEAX	2145570
	<ul style="list-style-type: none"> <li>• <b>Connection type head A:</b> Female connector, M12, 5-pin, straight, A-coded</li> <li>• <b>Connection type head B:</b> Flying leads</li> <li>• <b>Signal type:</b> Sensor/actuator cable</li> <li>• <b>Cable:</b> 3 m, 5-wire, PVC</li> <li>• <b>Description:</b> Sensor/actuator cable, unshielded</li> <li>• <b>Application:</b> Zones with chemicals, Uncontaminated zones</li> </ul>	YF2A15-030VB5XLEAX	2145572

## SICK AT A GLANCE

SICK is one of the leading manufacturers of intelligent sensors and sensor solutions for industrial applications. A unique range of products and services creates the perfect basis for controlling processes securely and efficiently, protecting individuals from accidents and preventing damage to the environment.

We have extensive experience in a wide range of industries and understand their processes and requirements. With intelligent sensors, we can deliver exactly what our customers need. In application centers in Europe, Asia and North America, system solutions are tested and optimized in accordance with customer specifications. All this makes us a reliable supplier and development partner.

Comprehensive services complete our offering: SICK LifeTime Services provide support throughout the machine life cycle and ensure safety and productivity.

For us, that is “Sensor Intelligence.”

## WORLDWIDE PRESENCE:

Contacts and other locations –[www.sick.com](http://www.sick.com)