



# OD2-P50W10C0

OD Value

DISPLACEMENT MEASUREMENT SENSORS

**SICK**  
Sensor Intelligence.



Illustration may differ



### Ordering information

Type	part no.
OD2-P50W10C0	6036599

Other models and accessories → [www.sick.com/OD\\_Value](http://www.sick.com/OD_Value)

### Detailed technical data

#### Features

<b>Measuring range</b>	40 mm ... 60 mm <sup>1)</sup>
<b>Target</b>	Natural objects
<b>Repeatability</b>	5 μm <sup>2) 3) 4)</sup>
<b>Linearity</b>	± 20 μm <sup>2) 3) 5)</sup>
<b>Response time</b>	≥ 1 ms
<b>Output time</b>	≥ 0.5 ms
<b>Light source</b>	Laser, red visible red light
<b>Type of light</b>	Visible red light
<b>Laser class</b>	2 (IEC 60825-1:2014, EN 60825-1:2014) <sup>6)</sup>
<b>Typ. light spot size (distance)</b>	0.5 mm x 1 mm (50 mm)
<b>Additional function</b>	Mean-value setting 1 ... 64x Automatic sensitivity adjustment Teach-in of digital output Invertable switching output Multifunctional input: laser-off / external teach-in / trigger Switching mode: distance to object (DtO) Switching mode: window (Wnd)
<b>Safety-related parameters</b>	
	MTTF <sub>D</sub> 101 years
	DC <sub>avg</sub> 0%

<sup>1)</sup> 6% ... 90% remission factor.

<sup>2)</sup> Measurement on 90 % remission (ceramic, white).

<sup>3)</sup> At averaging function medium.

<sup>4)</sup> Constant ambient conditions.

<sup>5)</sup> When calibrated in the application regularly.

<sup>6)</sup> Wavelength: 655 nm, max. output: 1 mW.

## Interfaces

<b>Digital output</b>	Number	2 <sup>1)</sup>
	Type	PNP
	Maximum output current $I_A$	≤ 100 mA
<b>Multifunctional input (MF)</b>		1 x MF <sup>2)</sup>

<sup>1)</sup> PNP: HIGH =  $V_S - (< 2 V)$  / LOW =  $< 2 V$ ; NPN: HIGH =  $< 2 V$  / LOW =  $V_S$ .

<sup>2)</sup> MF can be used as laser-off, trigger, external teach-in, or deactivated; response time ≤ 3 ms.

## Electronics

<b>Supply voltage <math>U_B</math></b>	DC 12 V ... 24 V
<b>Power consumption</b>	≤ 2.88 W <sup>1)</sup>
<b>Warm-up time</b>	≤ 30 min
<b>Indication</b>	Distance bar graph, up to 8 status LEDs
<b>Enclosure rating</b>	IP67
<b>Protection class</b>	III

<sup>1)</sup> Without load, with current output.

## Mechanics

<b>Dimensions (W x H x D)</b>	20.4 mm x 60 mm x 50 mm
<b>Housing material</b>	Plastic (PBT)
<b>Window material</b>	Plastic (PMMA)
<b>Weight</b>	70 g
<b>Connection type</b>	Male connector, M12, 8-pin, swivel connector unit

## Ambient data

<b>Ambient temperature, operation</b>	-10 °C ... +40 °C
<b>Ambient temperature, storage</b>	-20 °C ... +60 °C
<b>Relative air humidity (non-condensing)</b>	35 % ... 95 %
<b>Temperature drift</b>	± 0.08 % FS/K (FS = Full Scale = Measuring range of sensor)
<b>Typ. Ambient light immunity</b>	Artificial light: ≤ 3,000 lx Sunlight: ≤ 10,000 lx
<b>Vibration resistance</b>	10 Hz ... 55 Hz (amplitude 1.5 mm, x-, y-, z-axis 2 hours each)
<b>Shock resistance</b>	50 G (x, y, z axis 3 times each)

## Certificates

<b>EU declaration of conformity</b>	✓
<b>UK declaration of conformity</b>	✓
<b>ACMA declaration of conformity</b>	✓
<b>Moroccan declaration of conformity</b>	✓
<b>China RoHS</b>	✓
<b>Information according to Art. 3 of Data Act (Regulation EU 2023/2854)</b>	✓

## Classifications

<b>ECLASS 5.0</b>	27270801
-------------------	----------

# OD2-P50W10C0 | OD Value

## DISPLACEMENT MEASUREMENT SENSORS

<b>ECLASS 5.1.4</b>	27270801
<b>ECLASS 6.0</b>	27270801
<b>ECLASS 6.2</b>	27270801
<b>ECLASS 7.0</b>	27270801
<b>ECLASS 8.0</b>	27270801
<b>ECLASS 8.1</b>	27270801
<b>ECLASS 9.0</b>	27270801
<b>ECLASS 10.0</b>	27270801
<b>ECLASS 11.0</b>	27270801
<b>ECLASS 12.0</b>	27270916
<b>ETIM 5.0</b>	EC001825
<b>ETIM 6.0</b>	EC001825
<b>ETIM 7.0</b>	EC001825
<b>ETIM 8.0</b>	EC001825
<b>UNSPSC 16.0901</b>	41111613

### Dimensional drawing OD2-x50W10xx

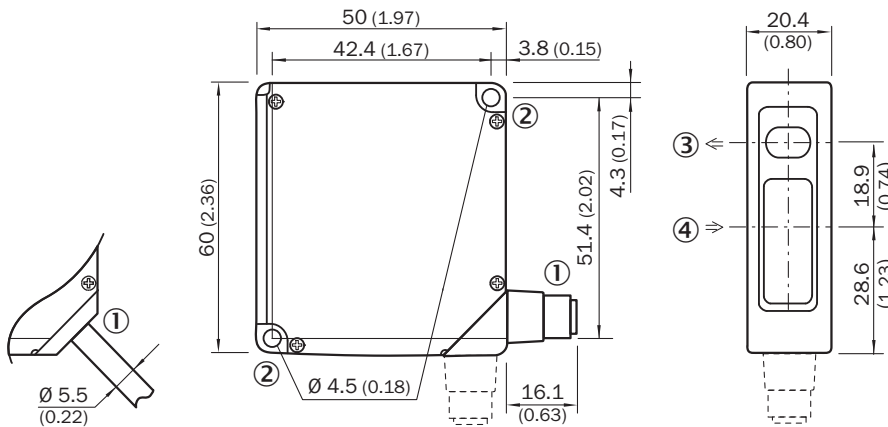

Dimensions in mm (inch)

- ① 2 m cable or M12 connector; 90° rotatable
- ② Mounting hole, Ø 4.5 mm
- ③ optical axis, sender
- ④ optical axis, receiver

### Connection type OD2-xxxxxA0 OD2-xxxxxC0 OD2-xxxxxI0 OD2-xxxxxU0 connector M12, 8-pin

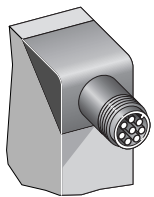

Connection diagram

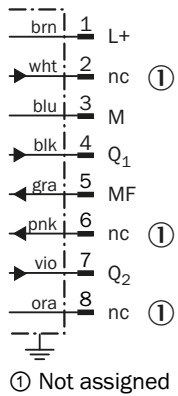

Adjustment possible OD2-xxxxxxCx

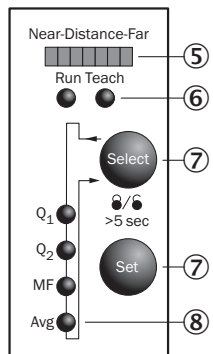

- ⑤ Distance indicator
- ⑥ mode indicator (Run/Teach)
- ⑦ Control elements
- ⑧ status indicator in- and outputs (Run-mode)/menu indicator (Teach-mode)

Light spot size OD2-x50W10xx

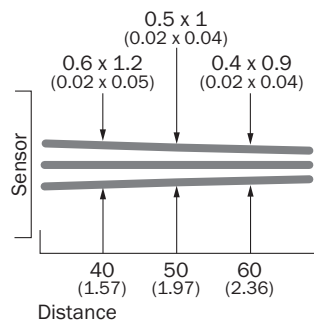

All dimensions in mm (inch)

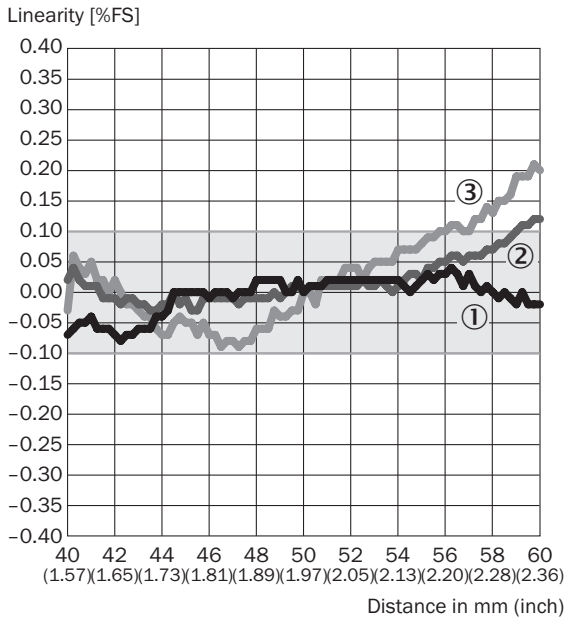

Linearity OD2-x50xxxxx



- ① White ceramic
- ② Black paper
- ③ stainless steel

Recommended accessories

Other models and accessories → [www.sick.com/OD\\_Value](http://www.sick.com/OD_Value)

	Brief description	Type	part no.
<b>connectors and cables</b>			
	<ul style="list-style-type: none"> <li>• <b>Connection type head A:</b> Female connector, M12, 8-pin, straight</li> <li>• <b>Connection type head B:</b> Flying leads</li> <li>• <b>Signal type:</b> Sensor/actuator cable</li> <li>• <b>Cable:</b> 2 m, 8-wire, PVC</li> <li>• <b>Description:</b> Sensor/actuator cable, special color code, shielded</li> <li>• <b>Connection systems:</b> Flying leads</li> </ul>	DOL-1208-G02MF	6020663
<b>Mounting systems</b>			
	<ul style="list-style-type: none"> <li>• <b>Description:</b> Stainless-steel mounting bracket</li> <li>• <b>Material:</b> Stainless steel</li> <li>• <b>Details:</b> Stainless steel</li> </ul>	BEF-WN-OD1000	4089813

## SICK AT A GLANCE

SICK is one of the leading manufacturers of intelligent sensors and sensor solutions for industrial applications. A unique range of products and services creates the perfect basis for controlling processes securely and efficiently, protecting individuals from accidents and preventing damage to the environment.

We have extensive experience in a wide range of industries and understand their processes and requirements. With intelligent sensors, we can deliver exactly what our customers need. In application centers in Europe, Asia and North America, system solutions are tested and optimized in accordance with customer specifications. All this makes us a reliable supplier and development partner.

Comprehensive services complete our offering: SICK LifeTime Services provide support throughout the machine life cycle and ensure safety and productivity.

For us, that is “Sensor Intelligence.”

## WORLDWIDE PRESENCE:

Contacts and other locations –[www.sick.com](http://www.sick.com)