



# C4C-EX10530A10000

deTec

**SAFETY LIGHT CURTAINS**

**SICK**  
Sensor Intelligence.



### Ordering information

Type	part no.
C4C-EX10530A10000	1220357

Other models and accessories → [www.sick.com/deTec](http://www.sick.com/deTec)

Illustration may differ



### Detailed technical data

#### Features

<b>Product version</b>	deTec4 Core Ex II 3GD
<b>Application</b>	Explosive areas
<b>Ex-approvals</b>	ATEX for gas: II 3G Ex ec op is IIC T4 Gc ATEX for dust: II 3D Ex tc IIIC T135° C Dc
<b>System part</b>	Receiver
<b>Compatible sender</b>	1220344
<b>Resolution</b>	30 mm
<b>Scanning range</b>	15 m
<b>Protective field height</b>	1,050 mm
<b>Response time</b>	11 ms
<b>No blind zones</b>	Yes
<b>Synchronization</b>	Optical synchronization
<b>Items supplied</b>	Receiver Test rod with diameter corresponding to the resolution of the safety light curtain “Notes for explosion protection” label(s) Safety instruction Mounting instructions Operating instructions for download

#### Safety-related parameters

<b>Type</b>	Type 4 (IEC 61496-1)
<b>Safety integrity level</b>	SIL 3 (IEC 61508)
<b>Category</b>	Category 4 (ISO 13849-1)
<b>Performance level</b>	PL e (ISO 13849-1)

<b>PFH<sub>D</sub> (mean probability of a dangerous failure per hour)</b>	3.7 x 10 <sup>-9</sup>
<b>T<sub>M</sub> (mission time)</b>	20 years (ISO 13849-1)
<b>Safe state in the event of a fault</b>	At least one OSSD is in the OFF state.

### Functions

<b>Protective operation</b>	✓
<b>Automatic calibration of the protective field width</b>	✓

### Interfaces

<b>System connection</b>	Plug, M12, 5-pin
Length of cable	150 mm
Cable diameter	4.3 mm
<b>Cable bend radius</b>	
Stationary position	> 12 x cable diameter
Flexible use	> 15 x cable diameter
<b>Display elements</b>	LEDs

### Electronics

<b>Protection class</b>	III (IEC 61140)
<b>Supply voltage V<sub>S</sub></b>	24 V DC (19.2 V ... 28.8 V)
<b>Ripple</b>	≤ 10 %
<b>Power consumption typical</b>	2.11 W (DC)
<b>Output signal switching devices (OSSDs)</b>	
Type of output	2 PNP semiconductors, short-circuit protected, cross-circuit monitored <sup>1)</sup>
ON state, switching voltage HIGH	24 V DC (V <sub>S</sub> - 2.25 V DC ... V <sub>S</sub> )
OFF state, switching voltage LOW	≤ 2 V DC
Current-carrying capacity per OSSD	≤ 300 mA

<sup>1)</sup> Applies to the voltage range between -30 V and +30 V.

### Mechanics

<b>Dimensions</b>	See dimensional drawing
<b>Housing material</b>	Aluminum extruded profile

### Ambient data

<b>Enclosure rating</b>	IP65 (IEC 60529) IP67 (IEC 60529)
<b>Ambient operating temperature</b>	0 °C ... +55 °C
<b>Storage temperature</b>	-30 °C ... +70 °C
<b>Air humidity</b>	15 % ... 95 %, Non-condensing
<b>Vibration resistance</b>	5 ... 150 Hz, 3,5 mm / 1 g (EN 60068-2-6)
<b>Shock resistance</b>	15 g / 6 ms (EN 60068-2-27)
<b>Class</b>	3M4 (IEC TR 60721-4-3)

### Certificates

<b>EU declaration of conformity</b>	✓
-------------------------------------	---

<b>UK declaration of conformity</b>	✓
<b>ACMA declaration of conformity</b>	✓
<b>Moroccan declaration of conformity</b>	✓
<b>China RoHS</b>	✓
<b>CCC certificate</b>	✓
<b>IECEx certificate</b>	✓
<b>ULus approval</b>	✓
<b>cUL approval</b>	✓
<b>Taiwan OSHA certificate</b>	✓
<b>Japan Press Safety certificate</b>	✓
<b>EC-Type-Examination approval</b>	✓
<b>China GB/T certificate</b>	✓
<b>Information according to Art. 3 of Data Act (Regulation EU 2023/2854)</b>	✓

Classifications

<b>ECLASS 5.0</b>	27272704
<b>ECLASS 5.1.4</b>	27272704
<b>ECLASS 6.0</b>	27272704
<b>ECLASS 6.2</b>	27272704
<b>ECLASS 7.0</b>	27272704
<b>ECLASS 8.0</b>	27272704
<b>ECLASS 8.1</b>	27272704
<b>ECLASS 9.0</b>	27272704
<b>ECLASS 10.0</b>	27272704
<b>ECLASS 11.0</b>	27272704
<b>ECLASS 12.0</b>	27272704
<b>ETIM 5.0</b>	EC002549
<b>ETIM 6.0</b>	EC002549
<b>ETIM 7.0</b>	EC002549
<b>ETIM 8.0</b>	EC002549
<b>UNSPSC 16.0901</b>	46171620

Dimensional drawing

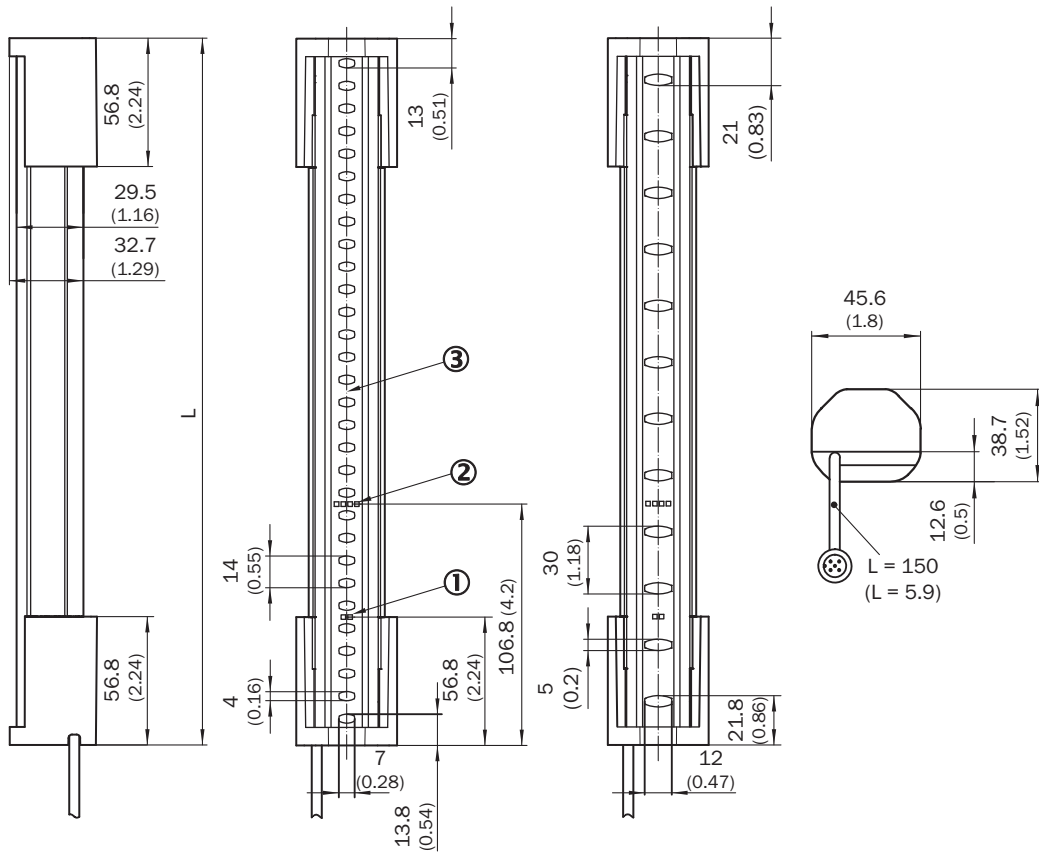





Dimensions in mm (inch)







- ① Operating indicator
- ② Alignment indicator
- ③ Optical axis

	L
300	313
450	463
600	613
750	763
900	913
1,050	1,063
1,200	1,213
1,350	1,362
1,500	1,512
1,650	1,662
1,800	1,812
1,950	1,962
2,100	2,112

### Recommended accessories

Other models and accessories → [www.sick.com/deTec](http://www.sick.com/deTec)

	Brief description	Type	part no.
Safety relays			
	<ul style="list-style-type: none"> <li>• <b>Applications:</b> Evaluation unit</li> <li>• <b>Compatible sensor types:</b> Safety sensors with OSSDs</li> <li>• <b>Connection type:</b> Front connector with spring terminals</li> <li>• <b>Restart interlock:</b> yes</li> <li>• <b>External device monitoring (EDM):</b> Integrated</li> <li>• <b>Outputs:</b> 3 enabling current paths (safe), 2 application diagnostic outputs (not safe), 1 test pulse output (not safe)</li> <li>• <b>Housing width:</b> 18 mm</li> </ul>	RLY3-OSSD300	1099969
	<ul style="list-style-type: none"> <li>• <b>Applications:</b> Evaluation unit</li> <li>• <b>Compatible sensor types:</b> Safety sensors with OSSDs</li> <li>• <b>Connection type:</b> Front connector with spring terminals</li> <li>• <b>Restart interlock:</b> yes</li> <li>• <b>External device monitoring (EDM):</b> Integrated</li> <li>• <b>Outputs:</b> 2 enabling current paths (safe), 2 application diagnostic outputs (not safe), 1 test pulse output (not safe)</li> <li>• <b>Housing width:</b> 18 mm</li> </ul>	RLY3-OSSD200	1085344
Mounting systems			
	<ul style="list-style-type: none"> <li>• <b>Description:</b> QuickFix bracket for 2 devices (e.g. sender and receiver)</li> <li>• <b>Material:</b> Plastic</li> <li>• <b>Details:</b> Plastic</li> <li>• <b>Packing unit:</b> 4 pieces</li> </ul>	BEF-3SHABPKU4	2098710
	<ul style="list-style-type: none"> <li>• <b>Description:</b> FlexFix bracket for 2 devices (e.g. sender and receiver), can be aligned <math>\pm 15^\circ</math>, including M5 screw</li> <li>• <b>Material:</b> Plastic</li> <li>• <b>Details:</b> Plastic</li> <li>• <b>Packing unit:</b> 4 pieces</li> </ul>	BEF-1SHABPKU4	2066614

	Brief description	Type	part no.
connectors and cables			
	<ul style="list-style-type: none"> <li>• <b>Connection type head A:</b> Female connector, M12, 5-pin, A-coded</li> <li>• <b>Connection type head B:</b> Female connector, M12, 5-pin, A-coded</li> <li>• <b>Connection type head C:</b> Male connector, M12, 5-pin, A-coded</li> <li>• <b>Description:</b> Unshielded</li> </ul>	DSC-1205T000025KMC	6030664
	<ul style="list-style-type: none"> <li>• <b>Connection type head A:</b> Female connector, M12, 5-pin, straight, A-coded</li> <li>• <b>Connection type head B:</b> Male connector, M12, 5-pin, straight, A-coded</li> <li>• <b>Signal type:</b> Sensor/actuator cable</li> <li>• <b>Cable:</b> 2 m, 5-wire, PUR, halogen-free</li> <li>• <b>Description:</b> Sensor/actuator cable, unshielded</li> <li>• <b>Application:</b> Uncontaminated zones, Zones with oils and lubricants, Robot, Drag chain operation</li> </ul>	YF2A15-020UB5M2A15	2096009
	<ul style="list-style-type: none"> <li>• <b>Connection type head A:</b> Female connector, M12, 5-pin, straight, A-coded</li> <li>• <b>Connection type head B:</b> Flying leads</li> <li>• <b>Signal type:</b> Sensor/actuator cable</li> <li>• <b>Cable:</b> 2 m, 5-wire, PUR, halogen-free</li> <li>• <b>Description:</b> Sensor/actuator cable, unshielded</li> <li>• <b>Application:</b> Uncontaminated zones, Zones with oils and lubricants, Robot, Drag chain operation</li> </ul>	YF2A15-020UB5XLEAX	2095617
	<ul style="list-style-type: none"> <li>• <b>Connection type head A:</b> Female connector, M12, 5-pin, straight, A-coded</li> <li>• <b>Connection type head B:</b> Male connector, M12, 5-pin, straight, A-coded</li> <li>• <b>Signal type:</b> Sensor/actuator cable</li> <li>• <b>Cable:</b> 5 m, 5-wire, PUR, halogen-free</li> <li>• <b>Description:</b> Sensor/actuator cable, unshielded</li> <li>• <b>Application:</b> Uncontaminated zones, Zones with oils and lubricants, Robot, Drag chain operation</li> </ul>	YF2A15-050UB5M2A15	2096010
	<ul style="list-style-type: none"> <li>• <b>Connection type head A:</b> Female connector, M12, 5-pin, straight, A-coded</li> <li>• <b>Connection type head B:</b> Flying leads</li> <li>• <b>Signal type:</b> Sensor/actuator cable</li> <li>• <b>Cable:</b> 5 m, 5-wire, PUR, halogen-free</li> <li>• <b>Description:</b> Sensor/actuator cable, unshielded</li> <li>• <b>Application:</b> Uncontaminated zones, Zones with oils and lubricants, Robot, Drag chain operation</li> </ul>	YF2A15-050UB5XLEAX	2095618
	<ul style="list-style-type: none"> <li>• <b>Connection type head A:</b> Female connector, M12, 5-pin, straight, A-coded</li> <li>• <b>Connection type head B:</b> Male connector, M12, 5-pin, straight, A-coded</li> <li>• <b>Signal type:</b> Sensor/actuator cable</li> <li>• <b>Cable:</b> 10 m, 5-wire, PUR, halogen-free</li> <li>• <b>Description:</b> Sensor/actuator cable, unshielded</li> <li>• <b>Application:</b> Uncontaminated zones, Zones with oils and lubricants, Robot, Drag chain operation</li> </ul>	YF2A15-100UB5M2A15	2096011
	<ul style="list-style-type: none"> <li>• <b>Connection type head A:</b> Female connector, M12, 5-pin, straight, A-coded</li> <li>• <b>Connection type head B:</b> Flying leads</li> <li>• <b>Signal type:</b> Sensor/actuator cable</li> <li>• <b>Cable:</b> 10 m, 5-wire, PUR, halogen-free</li> <li>• <b>Description:</b> Sensor/actuator cable, unshielded</li> <li>• <b>Application:</b> Uncontaminated zones, Zones with oils and lubricants, Robot, Drag chain operation</li> </ul>	YF2A15-100UB5XLEAX	2095619
Commissioning aids and test equipment			
	<ul style="list-style-type: none"> <li>• <b>Product:</b> Test equipment</li> <li>• <b>Description:</b> 30 mm diameter, 250 mm length</li> </ul>	Test rod 30 mm	2022602

## SICK AT A GLANCE

SICK is one of the leading manufacturers of intelligent sensors and sensor solutions for industrial applications. A unique range of products and services creates the perfect basis for controlling processes securely and efficiently, protecting individuals from accidents and preventing damage to the environment.

We have extensive experience in a wide range of industries and understand their processes and requirements. With intelligent sensors, we can deliver exactly what our customers need. In application centers in Europe, Asia and North America, system solutions are tested and optimized in accordance with customer specifications. All this makes us a reliable supplier and development partner.

Comprehensive services complete our offering: SICK LifeTime Services provide support throughout the machine life cycle and ensure safety and productivity.

For us, that is “Sensor Intelligence.”

## WORLDWIDE PRESENCE:

Contacts and other locations –[www.sick.com](http://www.sick.com)