



ZSE18-4AB3A3

Z18 Simple Sense

PHOTOELECTRIC SENSORS

SICK
Sensor Intelligence.



Ordering information

| Type | part no. |
|--------------|----------|
| ZSE18-4AB3A3 | 1095855 |

Included in delivery: BEF-MU-M18*1 (2)

Other models and accessories → www.sick.com/Z18_Simple_Sense

Illustration may differ



Detailed technical data

Features

| | |
|--|-----------------------------------|
| Functional principle | Through-beam photoelectric sensor |
| Dimensions (W x H x D) | 13.6 mm x 40.8 mm x 33.3 mm |
| Housing design (light emission) | Hybrid |
| Thread diameter (housing) | M18 |
| Mounting system type | M18, head/M18, base |
| Housing color | Blue |
| Sensing range max. | 0 m ... 17 m |
| Sensing range | 0 m ... 15 m |
| Type of light | Infrared light |
| Light source | LED |
| Light spot size (distance) | Ø 20 mm (500 mm) |
| Wave length | 850 nm |

Mechanics/electronics

| | |
|---|-------------------------------------|
| Supply voltage U_B | 10 V DC ... 30 V DC |
| Ripple | < 10 % |
| Current consumption | ≤ 15 mA ¹⁾ |
| Switching output | Push-pull: PNP/NPN |
| Switching mode | Light switching, Dark switching |
| Switching output detail | |
| Switching output Q1 | Push-pull: PNP/NPN, Light switching |
| Switching output Q2 | Push-pull: PNP/NPN, Dark switching |
| Output current $I_{max.}$ | 100 mA |

¹⁾ Without load.

²⁾ Signal transit time with resistive load.

³⁾ With light/dark ratio 1:1.

⁴⁾ A = V_S connections reverse-polarity protected.

⁵⁾ B = inputs and output reverse-polarity protected.

⁶⁾ D = outputs overcurrent and short-circuit protected.

| | |
|--------------------------------------|---|
| Response time | ≤ 500 μs ²⁾ |
| Switching frequency | 1,000 kHz ³⁾ |
| Connection type | Male connector M8, 4-pin |
| Circuit protection | A ⁴⁾ B ⁵⁾ D ⁶⁾ |
| Protection class | III |
| Weight | 4.54 g |
| Housing material | Plastic, ABS |
| Optics material | Plastic, PMMA |
| Enclosure rating | IP67 |
| Ambient operating temperature | -40 °C ... +55 °C |
| Ambient temperature, storage | -40 °C ... +70 °C |
| UL File No. | E189383 |

1) Without load.

2) Signal transit time with resistive load.

3) With light/dark ratio 1:1.

4) A = V_S connections reverse-polarity protected.

5) B = inputs and output reverse-polarity protected.

6) D = outputs overcurrent and short-circuit protected.

Connection type/pinouts

| | | |
|--|--------------------------|--------------------|
| Connection type | Male connector M8, 4-pin | |
| Pinouts <small>Sender</small> | BN 1 | + (L+) |
| | WH 2 | Not connected |
| | BU 3 | - (M) |
| | BK 4 | Test _{IN} |
| Pinouts <small>Receiver</small> | BN 1 | + (L+) |
| | WH 2 | Q ₂ |
| | BU 3 | - (M) |
| | BK 4 | Q ₁ |

Certificates

| | |
|---|---|
| EU declaration of conformity | ✓ |
| UK declaration of conformity | ✓ |
| ACMA declaration of conformity | ✓ |
| Moroccan declaration of conformity | ✓ |
| China RoHS | ✓ |

Classifications

| | |
|---------------------|----------|
| ECLASS 5.0 | 27270901 |
| ECLASS 5.1.4 | 27270901 |

| | |
|-----------------------|---------------|
| ECLASS 6.0 | 27270901 |
| ECLASS 6.2 | 27270901 |
| ECLASS 7.0 | 27270901 |
| ECLASS 8.0 | 27270901 |
| ECLASS 8.1 | 27270901 |
| ECLASS 9.0 | 27270901 |
| ECLASS 10.0 | 27270901 |
| ECLASS 11.0 | 27270901 |
| ECLASS 12.0 | 27270901 </td |
| ETIM 5.0 | EC002716 |
| ETIM 6.0 | EC002716 |
| ETIM 7.0 | EC002716 |
| ETIM 8.0 | EC002716 |
| UNSPSC 16.0901 | 39121528 |

Dimensional drawing

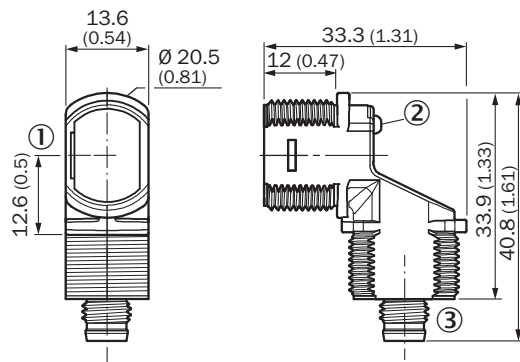

Dimensions in mm (inch)

- ① Optical axis
- ② LED status indicator
- ③ Connection

Pinouts, see table Technical data: Connection type/pinouts

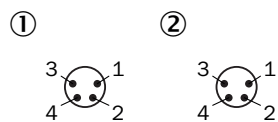

- ① sender
- ② receiver

Characteristic curve

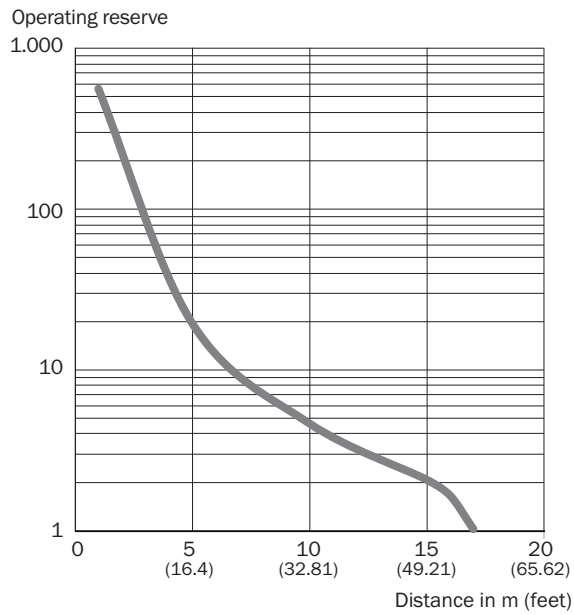



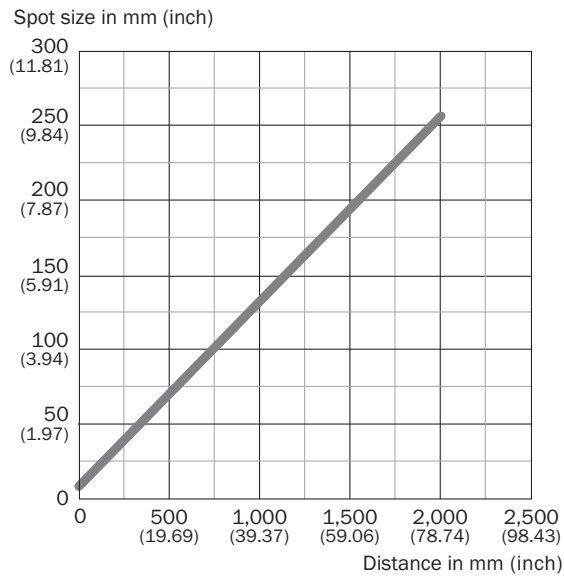

Light spot size



Recommended accessories

Other models and accessories → www.sick.com/Z18_Simple_Sense

| | Brief description | Type | part no. |
|--|--|--------------------|----------|
| Mounting systems | | | |
|  | <ul style="list-style-type: none"> Description: Mounting bracket for M18 sensors Material: Steel Details: Steel, zinc coated Items supplied: Without mounting hardware Suitable for: GR18, V180-2, V18, W15, Z1, Z2 | BEF-WN-M18 | 5308446 |
|  | <ul style="list-style-type: none"> Description: Plate N11N for universal clamp bracket Material: Stainless steel Details: Stainless steel 1.4571 (sheet), Stainless steel 1.4408 (clamp) Items supplied: Universal clamp (5322627), mounting hardware Usable for: DeltaPac, Glare, WTD20E | BEF-KHS-N11N | 2071081 |
| connectors and cables | | | |
|  | <ul style="list-style-type: none"> Connection type head A: Female connector, M8, 4-pin, straight, A-coded Connection type head B: Flying leads Signal type: Sensor/actuator cable Cable: 5 m, 4-wire, PVC Description: Sensor/actuator cable, unshielded Application: Zones with chemicals, Untaminated zones | YF8U14-050VA3XLEAX | 2095889 |
|  | <ul style="list-style-type: none"> Connection type head A: Male connector, M8, 4-pin, straight, A-coded Description: Unshielded Connection systems: Screw-type terminals Permitted cross-section: 0.14 mm² ... 0.5 mm² | STE-0804-G | 6037323 |
|  | <ul style="list-style-type: none"> Connection type head A: Female connector, M8, 4-pin, straight, A-coded Connection type head B: Flying leads Signal type: Sensor/actuator cable Cable: 5 m, 4-wire, PUR, halogen-free Description: Sensor/actuator cable, unshielded Application: Untaminated zones, Zones with oils and lubricants, Robot, Drag chain operation | YF8U14-050UA3XLEAX | 2094792 |

SICK AT A GLANCE

SICK is one of the leading manufacturers of intelligent sensors and sensor solutions for industrial applications. A unique range of products and services creates the perfect basis for controlling processes securely and efficiently, protecting individuals from accidents and preventing damage to the environment.

We have extensive experience in a wide range of industries and understand their processes and requirements. With intelligent sensors, we can deliver exactly what our customers need. In application centers in Europe, Asia and North America, system solutions are tested and optimized in accordance with customer specifications. All this makes us a reliable supplier and development partner.

Comprehensive services complete our offering: SICK LifeTime Services provide support throughout the machine life cycle and ensure safety and productivity.

For us, that is “Sensor Intelligence.”

WORLDWIDE PRESENCE:

Contacts and other locations –www.sick.com