



# MLG30A-2220R10501

MLG-2

AUTOMATION LIGHT GRIDS

**SICK**  
Sensor Intelligence.



Illustration may differ

### Ordering information

Type	part no.
MLG30A-2220R10501	1221886

Other models and accessories → [www.sick.com/MLG-2](http://www.sick.com/MLG-2)



### Detailed technical data

#### Features

<b>Device version</b>	Pro - Extended functionality										
<b>Sensor principle</b>	Sender/receiver										
<b>Minimum detectable object (MDO)</b>	30 mm <sup>1)</sup> 34 mm <sup>2)</sup> <sup>3)</sup>										
<b>Beam separation</b>	30 mm										
<b>Type of synchronization</b>	Cable										
<b>Number of beams</b>	75										
<b>Detection height</b>	2,220 mm										
<b>Software features (default)</b>	<table border="0"> <tr> <td>Q<sub>1</sub></td> <td>Presence detection</td> </tr> <tr> <td>Q<sub>2</sub> / IN</td> <td>Teach input</td> </tr> <tr> <td>Q<sub>3</sub></td> <td>Presence detection</td> </tr> <tr> <td>Q<sub>4</sub> / IN2</td> <td>Presence detection</td> </tr> <tr> <td>Teach</td> <td>Standard mode</td> </tr> </table>	Q <sub>1</sub>	Presence detection	Q <sub>2</sub> / IN	Teach input	Q <sub>3</sub>	Presence detection	Q <sub>4</sub> / IN2	Presence detection	Teach	Standard mode
Q <sub>1</sub>	Presence detection										
Q <sub>2</sub> / IN	Teach input										
Q <sub>3</sub>	Presence detection										
Q <sub>4</sub> / IN2	Presence detection										
Teach	Standard mode										
<b>Operating mode</b>	<table border="0"> <tr> <td>Standard</td> <td>✓</td> </tr> <tr> <td>Transparent</td> <td>✓</td> </tr> </table>	Standard	✓	Transparent	✓						
Standard	✓										
Transparent	✓										

<sup>1)</sup> MDO min. detectable object at high measurement accuracy.

<sup>2)</sup> MDO min. detectable object for standard measurement accuracy.

<sup>3)</sup> Depending on beam separation without cross beam setting.

Dust- and sunlight-resistant	✓
<b>Function</b>	
Cross beam	✓
Beam blanking	✓
High-speed scan	✓
High measurement accuracy	✓
<b>Applications</b>	
Switching output	Object detection/object width Object recognition Height classification Hole detection/hole size- Outside/inside dimension Object position Hole position Zone definition
Data interface	Object detection Hole detection Object height measurement Measurement of the outside dimension Measurement of the inside dimension Measurement of the object position Measurement of the hole position
<b>Included with delivery</b>	1 × sender 1 × receiver 4/6 × QuickFix brackets (6 × QuickFix brackets for monitoring heights above 2 m) 1 × Quick Start Guide

1) MDO min. detectable object at high measurement accuracy.

2) MDO min. detectable object for standard measurement accuracy.

3) Depending on beam separation without cross beam setting.

## Mechanics/electronics

<b>Light source</b>	LED, Infrared light
<b>Wave length</b>	850 nm
<b>Supply voltage <math>V_s</math></b>	DC 19.2 V ... 28.8 V <sup>1)</sup>
<b>Power consumption sender</b>	58.75 mA <sup>2)</sup>
<b>Power consumption receiver</b>	135 mA <sup>2)</sup>
<b>Ripple</b>	< 5 V <sub>pp</sub>
<b>Output current <math>I_{max}</math></b>	100 mA
<b>Output load, capacitive</b>	100 nF
<b>Output load, Inductive</b>	1 H
<b>Initialization time</b>	< 1 s
<b>Switching output</b>	Push-pull: PNP/NPN
<b>Connection type</b>	Plug, M12, 5-pin, 0.22 m Male connector M12, 8-pin, 0.27 m M12 female connector, 4-pin, D-coded, 0.19 m
<b>Housing material</b>	Aluminum
<b>Display</b>	LED
<b>Enclosure rating</b>	IP65, IP67 <sup>3)</sup>
<b>Circuit protection</b>	U <sub>v</sub> connections, reverse polarity protected Output Q short-circuit protected Interference pulse suppression
<b>Protection class</b>	III
<b>Weight</b>	4.749 kg

1) Without load.

2) Without load with 24 V.

3) Operating in outdoor condition only with a external protection housing.

<b>Front screen</b>	PMMA
<b>Option</b>	None
<b>UL File No.</b>	NRKH.E181493

<sup>1)</sup> Without load.

<sup>2)</sup> Without load with 24 V.

<sup>3)</sup> Operating in outdoor condition only with a external protection housing.

### Performance

<b>Maximum range</b>	7 m <sup>1)</sup>
<b>Minimum range</b>	≥ 0 m
<b>Operating range</b>	5 m
<b>Response time</b>	7.1 ms <sup>2)</sup>

<sup>1)</sup> No reserve for environmental issue and deterioration of the diode.

<sup>2)</sup> Without high speed.

### Interfaces

<b>IO-Link</b>	✓ , IO-Link V1.1
Data transmission rate	230,4 kbit/s (COM3)
Maximum cable length	20 m
Cycle time	2.3 ms
VendorID	26
DeviceID HEX	800068
DeviceID DEC	8388712
Process data length	32 Byte (TYPE_2_V) <sup>1)</sup>
<b>Inputs/outputs</b>	4 x Q (IO-Link)
<b>Digital output</b>	Q <sub>1</sub> ... Q <sub>4</sub>
Number	4
<b>Digital input</b>	In <sub>1</sub> , In <sub>2</sub>
Number	2

<sup>1)</sup> For an IO-Link master with V1.0, reverts to interleaved mode (consisting of TYPE\_1\_1 (ProcessData) and TYPE\_1\_2 (on-request data)).

### Ambient data

<b>Shock resistance</b>	Continuous shocks 10 g, 16 ms, 1000 shocks Single shocks 15 g, 11 ms 3 per axle
<b>Vibration resistance</b>	Sinusoidal oscillation 10-150 Hz 5 g
<b>EMC</b>	EN 60947-5-2
<b>Ambient light immunity</b>	Direct: 150,000 lx <sup>1)</sup> Indirect: 200,000 lx <sup>2)</sup>
<b>Ambient operating temperature</b>	-30 °C ... +55 °C
<b>Ambient temperature, storage</b>	-40 °C ... +70 °C

<sup>1)</sup> Outdoor mode.

<sup>2)</sup> Light resistance indirect.

### Smart Task

<b>Smart Task name</b>	Base logics
------------------------	-------------

## Certificates

<b>EU declaration of conformity</b>	✓
<b>UK declaration of conformity</b>	✓
<b>ACMA declaration of conformity</b>	✓
<b>Moroccan declaration of conformity</b>	✓
<b>China-RoHS</b>	✓
<b>cULus certificate</b>	✓
<b>IO-Link</b>	✓
<b>Photobiological safety (IEC EN 62471)</b>	✓

## Classifications

<b>ECLASS 5.0</b>	27270910
<b>ECLASS 5.1.4</b>	27270910
<b>ECLASS 6.0</b>	27270910
<b>ECLASS 6.2</b>	27270910
<b>ECLASS 7.0</b>	27270910
<b>ECLASS 8.0</b>	27270910
<b>ECLASS 8.1</b>	27270910
<b>ECLASS 9.0</b>	27270910
<b>ECLASS 10.0</b>	27270910
<b>ECLASS 11.0</b>	27270910
<b>ECLASS 12.0</b>	27270910
<b>ETIM 5.0</b>	EC002549
<b>ETIM 6.0</b>	EC002549
<b>ETIM 7.0</b>	EC002549
<b>ETIM 8.0</b>	EC002549
<b>UNSPSC 16.0901</b>	39121528

### Dimensional drawing



	A <sup>1)</sup>	B <sup>2)</sup>
<b>Strahlabstand 2,5 mm</b>	62,25	17,15
<b>Strahlabstand 5 mm</b>	63,3	16,1
<b>Strahlabstand 10 mm</b>	68,3	16,1
<b>Strahlabstand 20 mm</b>	68,3/78,3 <sup>3)</sup>	16,1
<b>Strahlabstand 25 mm</b>	83,3	16,1
<b>Strahlabstand 30 mm</b>	88,3	16,1
<b>Strahlabstand 50 mm</b>	108,3	16,1

<sup>1)</sup> Abstand: MLG-2 Kante - erster Strahl

<sup>2)</sup> Abstand: MLG-2 Kante - letzter Strahl

<sup>3)</sup> MLG20x-xx**40**: 68,3 mm

MLG20x-xx**80**: 78,3 mm

#### Dimensions in mm (inch)

- ① First beam
- ② last beam
- ③ detection height (see technical data)
- ④ Beam separation
- ⑤ Optical axis
- ⑥ status indicator: green, yellow, red LEDs
- ⑦ Connection

Connection type and diagram Connector M12, 5/8-pin, switching outputs Q

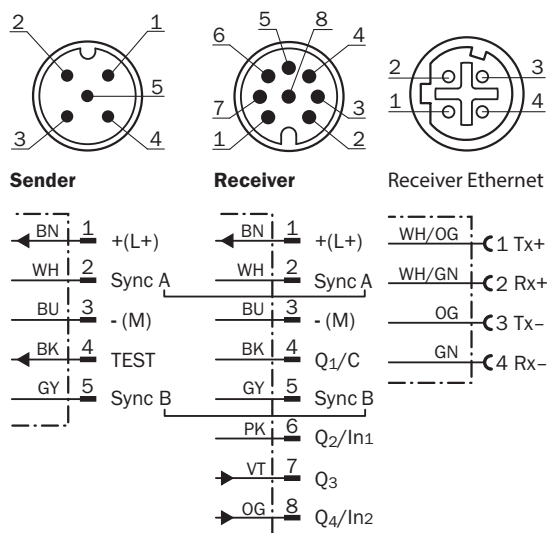

Pinouts



- ① Connection cable receiver (2096010)
- ② T-piece
- ③ Connection cable (6020664)
- ④ Ethernet Connection cable

### Adjustments



① status indicator: green, yellow, red LEDs

### Connection diagram T-splitter, IO-Link Master



Connection diagram T-splitter, PLC



Recommended accessories

Other models and accessories → [www.sick.com/MLG-2](http://www.sick.com/MLG-2)

	Brief description	Type	part no.
connectors and cables			
	<ul style="list-style-type: none"> <li><b>Connection type head A:</b> Female connector, M12, 5-pin, A-coded</li> <li><b>Connection type head B:</b> Female connector, M12, 8-pin, A-coded</li> <li><b>Connection type head C:</b> Male connector, M12, 8-pin, A-coded</li> <li><b>Description:</b> Unshielded</li> <li><b>Note:</b> For connecting of a PLC</li> </ul>	SBO-02F12-SM1	6053172
	<ul style="list-style-type: none"> <li><b>Connection type head A:</b> Female connector, M12, 8-pin, straight</li> <li><b>Connection type head B:</b> Flying leads</li> <li><b>Signal type:</b> Sensor/actuator cable</li> <li><b>Cable:</b> 5 m, 8-wire, PVC</li> <li><b>Description:</b> Sensor/actuator cable, special color code, shielded</li> <li><b>Connection systems:</b> Flying leads</li> </ul>	DOL-1208-G05MF	6020664
	<ul style="list-style-type: none"> <li><b>Connection type head A:</b> Female connector, M12, 5-pin, straight, A-coded</li> <li><b>Connection type head B:</b> Male connector, M12, 5-pin, straight, A-coded</li> <li><b>Signal type:</b> Sensor/actuator cable</li> <li><b>Cable:</b> 5 m, 5-wire, PUR, halogen-free</li> <li><b>Description:</b> Sensor/actuator cable, unshielded</li> <li><b>Application:</b> Uncontaminated zones, Zones with oils and lubricants, Robot, Drag chain operation</li> </ul>	YF2A15-050UB5M2A15	2096010
	<ul style="list-style-type: none"> <li><b>Connection type head A:</b> Male connector, M12, 4-pin, straight, D-coded</li> <li><b>Connection type head B:</b> Male connector, RJ45, 4-pin, straight</li> <li><b>Signal type:</b> Ethernet, PROFINET</li> <li><b>Cable:</b> 5 m, 4-wire, PUR, halogen-free</li> <li><b>Description:</b> Ethernet, shielded, PROFINET</li> <li><b>Application:</b> Drag chain operation, Zones with oils and lubricants</li> </ul>	YM2D24-050P-N1MRJA4	2106184

	Brief description	Type	part no.
network devices			
		SIG350-0004AP100	6076871
		SIG350-0006AP100	6076924
		SIG350-0005AP100	6076923

## SICK AT A GLANCE

SICK is one of the leading manufacturers of intelligent sensors and sensor solutions for industrial applications. A unique range of products and services creates the perfect basis for controlling processes securely and efficiently, protecting individuals from accidents and preventing damage to the environment.

We have extensive experience in a wide range of industries and understand their processes and requirements. With intelligent sensors, we can deliver exactly what our customers need. In application centers in Europe, Asia and North America, system solutions are tested and optimized in accordance with customer specifications. All this makes us a reliable supplier and development partner.

Comprehensive services complete our offering: SICK LifeTime Services provide support throughout the machine life cycle and ensure safety and productivity.

For us, that is “Sensor Intelligence.”

## WORLDWIDE PRESENCE:

Contacts and other locations –[www.sick.com](http://www.sick.com)