



# AHS36A-S1QJ016384

AHS/AHM36

**ABSOLUTE ENCODERS**

**SICK**  
Sensor Intelligence.



Illustration may differ



### Ordering information

Type	part no.
AHS36A-S1QJ016384	1101560

Other models and accessories → [www.sick.com/AHS\\_AHM36](http://www.sick.com/AHS_AHM36)

### Detailed technical data

#### Safety-related parameters

<b>MTTF<sub>D</sub> (mean time to dangerous failure)</b>	240 years (EN ISO 13849-1) <sup>1)</sup>
----------------------------------------------------------	------------------------------------------

<sup>1)</sup> This product is a standard product and does not constitute a safety component as defined in the Machinery Directive. Calculation based on nominal load of components, average ambient temperature 40 °C, frequency of use 8760 h/a. All electronic failures are considered hazardous. For more information, see document no. 8015532.

#### Performance

<b>Number of steps per revolution (max. resolution)</b>	16,384 (14 bit)
<b>Error limits G</b>	0.35° (at 20 °C) <sup>1)</sup>
<b>Repeatability standard deviation <math>\sigma_r</math></b>	0.2° (at 20 °C) <sup>2)</sup>

<sup>1)</sup> In accordance with DIN ISO 1319-1, position of the upper and lower error limit depends on the installation situation, specified value refers to a symmetrical position, i.e. deviation in upper and lower direction is the same.

<sup>2)</sup> In accordance with DIN ISO 55350-13; 68.3% of the measured values are inside the specified area.

#### Interfaces

<b>Communication interface</b>	IO-Link
<b>Communication Interface detail</b>	IO-Link V1.1 / COM3 (230,4 kBaud)
<b>Initialization time</b>	2 s <sup>1)</sup>
<b>Cycle time</b>	≤ 3.2 ms
<b>Smart Sensor</b>	Efficient communication, Enhanced Sensing, diagnosis
<b>Process data</b>	Position, speed, electronic cams, limit values, linear position, linear speed, errors and warnings, switching signals on pin 2
<b>Parameterising data</b>	Number of steps per revolution PRESET Counting direction

<sup>1)</sup> Valid positional data can be read once this time has elapsed.

	Sampling rate for speed calculation Unit for output of the speed value Electronic cams(2 channels x 8 cams) Limit values Linear measuring length per 360° Pin 2 configuration
<b>Available diagnostics data</b>	Minimum and maximum temperature Maximum speed Power-on counter Operating hours counter power-on/motion Counter of direction changes/number of movements cw/number of movements ccw Minimum and maximum operating voltage Distance covered
<b>Status information</b>	Via status LED
<b>Switching input/Switching output</b>	✓
<b>Pin 2 input frequency</b>	≤ 100 Hz
<b>Output frequency pin 2</b>	≤ 100 Hz

<sup>1)</sup> Valid positional data can be read once this time has elapsed.

## Electronics

<b>Connection type</b>	Cable, 4-wire, universal, 0.5 m
<b>Supply voltage</b>	18 ... 30 V
<b>Power consumption</b>	≤ 1.5 W
<b>Reverse polarity protection</b>	✓

## Mechanics

<b>Mechanical design</b>	Solid shaft, Servo flange
<b>Shaft diameter</b>	6 mm
<b>Shaft length</b>	12 mm
<b>Characteristics of the shaft</b>	With flat
<b>Weight</b>	0.12 kg <sup>1)</sup>
<b>Shaft material</b>	Stainless steel
<b>Flange material</b>	Aluminum
<b>Housing material</b>	Zinc
<b>Start up torque</b>	< 1 Ncm (+20 °C)
<b>Operating torque</b>	< 1 Ncm (+20 °C)
<b>Permissible shaft loading</b>	40 N (radial) 20 N (axial)
<b>Operating speed</b>	≤ 6,000 min <sup>-1</sup>
<b>Moment of inertia of the rotor</b>	2.5 gcm <sup>2</sup>
<b>Bearing lifetime</b>	3.6 x 10 <sup>8</sup> revolutions
<b>Angular acceleration</b>	≤ 500,000 rad/s <sup>2</sup>

<sup>1)</sup> Based on devices with male connector.

## Ambient data

<b>EMC</b>	According to EN 61000-6-2, EN 61000-6-3 and EN 61131-9
<b>Enclosure rating</b>	IP66 (IEC 60529) IP67 (IEC 60529)
<b>Permissible relative humidity</b>	90 % (Condensation not permitted)

<b>Operating temperature range</b>	-40 °C ... +85 °C
<b>Storage temperature range</b>	-40 °C ... +100 °C, without package
<b>Resistance to shocks</b>	100 g, 6 ms (EN 60068-2-27)
<b>Resistance to vibration</b>	20 g, 10 Hz ... 2,000 Hz (EN 60068-2-6)

### Certificates

<b>EU declaration of conformity</b>	✓
<b>UK declaration of conformity</b>	✓
<b>ACMA declaration of conformity</b>	✓
<b>Moroccan declaration of conformity</b>	✓
<b>China-RoHS</b>	✓
<b>IO-Link</b>	✓
<b>cTUVus certificate</b>	✓
<b>Information according to Art. 3 of Data Act (Regulation EU 2023/2854)</b>	✓

### Classifications

<b>ECLASS 5.0</b>	27270502
<b>ECLASS 5.1.4</b>	27270502
<b>ECLASS 6.0</b>	27270590
<b>ECLASS 6.2</b>	27270590
<b>ECLASS 7.0</b>	27270502
<b>ECLASS 8.0</b>	27270502
<b>ECLASS 8.1</b>	27270502
<b>ECLASS 9.0</b>	27270502
<b>ECLASS 10.0</b>	27270502
<b>ECLASS 11.0</b>	27270502
<b>ECLASS 12.0</b>	27270502
<b>ETIM 5.0</b>	EC001486
<b>ETIM 6.0</b>	EC001486
<b>ETIM 7.0</b>	EC001486
<b>ETIM 8.0</b>	EC001486
<b>UNSPSC 16.0901</b>	41112113

Dimensional drawing Solid shaft, servo flange, cable

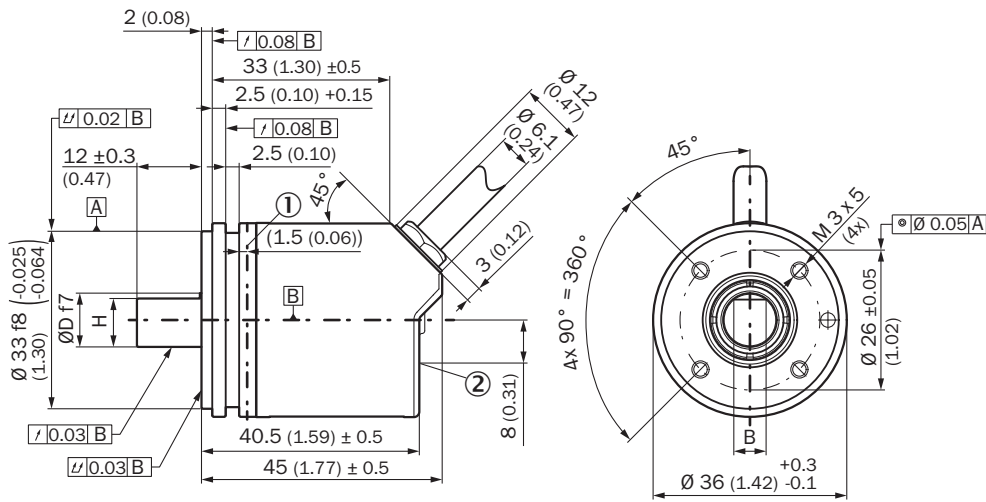

Dimensions in mm (inch)

- ① Measuring point for operating temperature
- ② measuring point for vibrations

Type	Shaft diameter $\varnothing D f7$	B	H
AHx36x-S1xxxxxxxx AHx36x-S3xxxxxxxx	6 mm	3,6 mm	5,4 mm
AHx36x-S9xxxxxxxx AHx36x-S5xxxxxxxx	8 mm	3,9 mm	7,5 mm
AHx36x-S2xxxxxxxx AHx36x-S4xxxxxxxx AHx36x-SCxxxxxxxx	10 mm	6 mm	9 mm
AHx36x-SAxxxxxxxx AHx36x-S8xxxxxxxx	1/4"	3,85 mm	5,7 mm
AHx36x-SBxxxxxxxx AHx36x-S7xxxxxxxx	3/8"	4,35 mm	9 mm

Anschlussbelegung

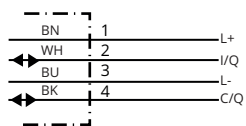







PIN	Wire color	Signal	Function		
-	-	-	Basic	Advanced	Advanced Smart Task
1	Brown	L+	Encoder supply voltage 18-30 V (+Us)		
2	White	I/Q	Not connect- ed - no function	Multifunctional pin (configurable as switching input or switching output)	
3	Blue	L-	Encoder supply voltage 0 V (GND)		
4	Black	C/Q	IO-Link communication		
		-			Switching out- put (SIO mode)

### Recommended accessories

Other models and accessories → [www.sick.com/AHS\\_AHM36](http://www.sick.com/AHS_AHM36)

	Brief description	Type	part no.
connectors and cables			
	<ul style="list-style-type: none"> <li><b>Connection type head A:</b> Female connector, M12, 4-pin, straight, A-coded</li> <li><b>Description:</b> Unshielded</li> <li><b>Connection systems:</b> Screw-type terminals</li> <li><b>Permitted cross-section:</b> ≤ 0.75 mm<sup>2</sup></li> </ul>	DOS-1204-G	6007302
	<ul style="list-style-type: none"> <li><b>Connection type head A:</b> Female connector, M12, 4-pin, straight, A-coded</li> <li><b>Connection type head B:</b> Male connector, M12, 4-pin, straight, A-coded</li> <li><b>Signal type:</b> Sensor/actuator cable</li> <li><b>Cable:</b> 2 m, 4-wire, PUR, halogen-free</li> <li><b>Description:</b> Sensor/actuator cable, unshielded</li> <li><b>Application:</b> Uncontaminated zones, Zones with oils and lubricants, Robot, Drag chain operation</li> </ul>	YF2A14-020UB3M2A14	2096000
	<ul style="list-style-type: none"> <li><b>Connection type head A:</b> Female connector, M12, 4-pin, straight, A-coded</li> <li><b>Connection type head B:</b> Male connector, M12, 4-pin, straight, A-coded</li> <li><b>Signal type:</b> Sensor/actuator cable</li> <li><b>Cable:</b> 5 m, 4-wire, PUR, halogen-free</li> <li><b>Description:</b> Sensor/actuator cable, unshielded</li> <li><b>Application:</b> Uncontaminated zones, Zones with oils and lubricants, Robot, Drag chain operation</li> </ul>	YF2A14-050UB3M2A14	2096001
	<ul style="list-style-type: none"> <li><b>Connection type head A:</b> Female connector, M12, 4-pin, straight, A-coded</li> <li><b>Connection type head B:</b> Male connector, M12, 4-pin, straight, A-coded</li> <li><b>Signal type:</b> Sensor/actuator cable</li> <li><b>Cable:</b> 10 m, 4-wire, PUR, halogen-free</li> <li><b>Description:</b> Sensor/actuator cable, unshielded</li> <li><b>Application:</b> Uncontaminated zones, Zones with oils and lubricants, Robot, Drag chain operation</li> </ul>	YF2A14-100UB3M2A14	2096002
	<ul style="list-style-type: none"> <li><b>Connection type head A:</b> Female connector, M12, 4-pin, straight, A-coded</li> <li><b>Connection type head B:</b> Flying leads</li> <li><b>Signal type:</b> Sensor/actuator cable</li> <li><b>Cable:</b> 2 m, 4-wire, PUR, halogen-free</li> <li><b>Description:</b> Sensor/actuator cable, unshielded</li> <li><b>Application:</b> Uncontaminated zones, Zones with oils and lubricants, Robot, Drag chain operation</li> </ul>	YF2A14-020UB3XLEAX	2095607
	<ul style="list-style-type: none"> <li><b>Connection type head A:</b> Female connector, M12, 4-pin, straight, A-coded</li> <li><b>Connection type head B:</b> Flying leads</li> <li><b>Signal type:</b> Sensor/actuator cable</li> <li><b>Cable:</b> 5 m, 4-wire, PUR, halogen-free</li> <li><b>Description:</b> Sensor/actuator cable, unshielded</li> <li><b>Application:</b> Uncontaminated zones, Zones with oils and lubricants, Robot, Drag chain operation</li> </ul>	YF2A14-050UB3XLEAX	2095608
	<ul style="list-style-type: none"> <li><b>Connection type head A:</b> Female connector, M12, 4-pin, straight, A-coded</li> <li><b>Connection type head B:</b> Flying leads</li> <li><b>Signal type:</b> Sensor/actuator cable</li> <li><b>Cable:</b> 10 m, 4-wire, PUR, halogen-free</li> <li><b>Description:</b> Sensor/actuator cable, unshielded</li> <li><b>Application:</b> Uncontaminated zones, Zones with oils and lubricants, Robot, Drag chain operation</li> </ul>	YF2A14-100UB3XLEAX	2095609
	<ul style="list-style-type: none"> <li><b>Connection type head A:</b> Female connector, M12, 4-pin, straight, A-coded</li> <li><b>Connection type head B:</b> Flying leads</li> <li><b>Signal type:</b> Sensor/actuator cable</li> <li><b>Cable:</b> 0.6 m, 4-wire, PUR, halogen-free</li> <li><b>Description:</b> Sensor/actuator cable, unshielded</li> <li><b>Application:</b> Uncontaminated zones, Zones with oils and lubricants, Robot, Drag chain operation</li> </ul>	YF2A14-C60UB3XLEAX	2145654
	<ul style="list-style-type: none"> <li><b>Connection type head A:</b> Female connector, M12, 4-pin, straight, A-coded</li> <li><b>Connection type head B:</b> Flying leads</li> <li><b>Signal type:</b> Sensor/actuator cable</li> <li><b>Cable:</b> 1 m, 4-wire, PUR, halogen-free</li> <li><b>Description:</b> Sensor/actuator cable, unshielded</li> <li><b>Application:</b> Uncontaminated zones, Zones with oils and lubricants, Robot, Drag chain operation</li> </ul>	YF2A14-010UB3XLEAX	2145655
	<ul style="list-style-type: none"> <li><b>Connection type head A:</b> Female connector, M12, 4-pin, straight, A-coded</li> <li><b>Connection type head B:</b> Flying leads</li> <li><b>Signal type:</b> Sensor/actuator cable</li> <li><b>Cable:</b> 3 m, 4-wire, PUR, halogen-free</li> <li><b>Description:</b> Sensor/actuator cable, unshielded</li> <li><b>Application:</b> Uncontaminated zones, Zones with oils and lubricants, Robot, Drag chain operation</li> </ul>	YF2A14-030UB3XLEAX	2145656

	Brief description	Type	part no.
measuring wheels and measuring wheel mechanics			
	<ul style="list-style-type: none"> <li><b>Product segment:</b> Measuring wheels and measuring wheel mechanics</li> <li><b>Product family:</b> Measuring wheel mechanics</li> <li><b>Description:</b> O-ring for measuring wheels (circumference 200 mm)</li> </ul>	BEF-OR-053-040	2064061
	<ul style="list-style-type: none"> <li><b>Product segment:</b> Measuring wheels and measuring wheel mechanics</li> <li><b>Product family:</b> Measuring wheels</li> <li><b>Description:</b> Measuring wheel with O-ring (NBR70) for 6 mm solid shaft, circumference 300 mm</li> </ul>	BEF-MR006030R	2055634
	<ul style="list-style-type: none"> <li><b>Product segment:</b> Measuring wheels and measuring wheel mechanics</li> <li><b>Product family:</b> Measuring wheel mechanics</li> <li><b>Description:</b> O-ring for measuring wheels (circumference 300 mm)</li> <li><b>Items supplied:</b> 2x O-ring</li> </ul>	BEF-OR-083-050	2064076
shaft adaptation			
	<ul style="list-style-type: none"> <li><b>Product segment:</b> Shaft adaptation</li> <li><b>Product:</b> Shaft couplings</li> <li><b>Description:</b> Bellows coupling, shaft diameter 6 mm / 6 mm, maximum shaft offset: radial ± 0.25 mm, axial ± 0.4 mm, angular +/- 4°; max. speed 10,000 rpm, -30 °C to +120 °C, max. torque 120 Ncm; material: stainless steel bellows, aluminum hub</li> </ul>	KUP-0606-B	5312981
	<ul style="list-style-type: none"> <li><b>Product segment:</b> Shaft adaptation</li> <li><b>Product:</b> Shaft couplings</li> <li><b>Description:</b> Bellows coupling, shaft diameter 6 mm / 10 mm, maximum shaft offset: radial ± 0.25 mm, axial ± 0.4 mm, angular +/- 4°; max. speed 10,000 rpm, -30 °C to +120 °C, max. torque 120 Ncm; material: stainless steel bellows, aluminum hub</li> </ul>	KUP-0610-B	5312982
	<ul style="list-style-type: none"> <li><b>Product segment:</b> Shaft adaptation</li> <li><b>Product:</b> Shaft couplings</li> <li><b>Description:</b> Double loop coupling, shaft diameter 6 mm / 10 mm, max. shaft offset: radially +/- 2,5 mm, axially +/- 3 mm, angle +/- 10 degrees; max. speed 3.000 rpm, -30 to +80 degrees Celsius, torsional spring stiffness of 25 Nm/rad</li> </ul>	KUP-0610-D	5326697
	<ul style="list-style-type: none"> <li><b>Product segment:</b> Shaft adaptation</li> <li><b>Product:</b> Shaft couplings</li> <li><b>Description:</b> Spring washer coupling, shaft diameter 6 mm / 10 mm, Maximum shaft offset: radial +/- 0.3 mm, axial +/- 0.4 mm, angular +/- 2.5°; max. speed 12,000 rpm, -10° to +80 °C, max. torque 60 Ncm; material: aluminum flange, glass fiber-reinforced polyamide membrane and hardened steel coupling pin</li> </ul>	KUP-0610-F	5312985
	<ul style="list-style-type: none"> <li><b>Product segment:</b> Shaft adaptation</li> <li><b>Product:</b> Shaft couplings</li> <li><b>Description:</b> Claw coupling, shaft diameter 6 mm / 10 mm, damping element 80 shore blue, maximum shaft offset: radial ± 0.22 mm, axial ± 1 mm angular ± 1.3°, max. speed 19,000 rpm, angle of twist max. 10°, -30 °C to +80 °C, max. torque 800 Ncm, tightening torque of screws: ISO 4029 150 Ncm, material: aluminum flange, damping element: polyurethane</li> </ul>	KUP-0610-J	2127056

## SICK AT A GLANCE

SICK is one of the leading manufacturers of intelligent sensors and sensor solutions for industrial applications. A unique range of products and services creates the perfect basis for controlling processes securely and efficiently, protecting individuals from accidents and preventing damage to the environment.

We have extensive experience in a wide range of industries and understand their processes and requirements. With intelligent sensors, we can deliver exactly what our customers need. In application centers in Europe, Asia and North America, system solutions are tested and optimized in accordance with customer specifications. All this makes us a reliable supplier and development partner.

Comprehensive services complete our offering: SICK LifeTime Services provide support throughout the machine life cycle and ensure safety and productivity.

For us, that is “Sensor Intelligence.”

## WORLDWIDE PRESENCE:

Contacts and other locations –[www.sick.com](http://www.sick.com)