



# OD1-B035C15A14

OD Mini

DISPLACEMENT MEASUREMENT SENSORS

**SICK**  
Sensor Intelligence.



Illustration may differ



## Ordering information

Type	part no.
OD1-B035C15A14	6050525

Other models and accessories → [www.sick.com/OD\\_Mini](http://www.sick.com/OD_Mini)

## Detailed technical data

### Features

<b>Measuring range</b>	20 mm ... 50 mm
<b>Target</b>	Natural objects
<b>Repeatability</b>	6 μm <sup>1) 2)</sup>
<b>Linearity</b>	± 30 μm <sup>3)</sup>
<b>Response time</b>	≥ 2 ms <sup>4)</sup>
<b>Output time</b>	≥ 0.5 ms
<b>Light source</b>	Laser, red visible red light
<b>Type of light</b>	Visible red light
<b>Laser class</b>	1 (IEC 60825-1:2014, EN 60825-1:2014) <sup>5)</sup>
<b>Typ. light spot size (distance)</b>	800 μm x 450 μm (35 mm)
<b>Additional function</b>	Averaging 1 ... 512x Automatic or manual sensitivity adjustment Switching mode: window (Wnd) Switching mode: distance to object (DtO) Switching mode: object between sensor and background (ObSB) Multifunctional input: laser-off / external teach-in / trigger
<b>General notes</b>	
Note on use	The sensor head can be used with evaluation unit AOD1 or stand-alone via RS-485
Note	Not free of paint wetting impairment substances.
<b>Safety-related parameters</b>	

<sup>1)</sup> Averaging function set to: 512.

<sup>2)</sup> Constant ambient conditions.

<sup>3)</sup> Measurement on 90 % remission (ceramic, white).

<sup>4)</sup> With fixed sensitivity adjustment and averaging setting = 1. With automatic sensitivity and measuring rate 500 μs: 2 ... 7.5 ms response time/measuring rate 1,000 μs: 4 ... 15 ms response time.

<sup>5)</sup> Wavelength: 655 nm, max. output: 390 μW (laser class 1) / < 1 mW (laser class 2).

MTTF <sub>D</sub>	101 years
DC <sub>avg</sub>	0%

- 1) Averaging function set to: 512.  
 2) Constant ambient conditions.  
 3) Measurement on 90 % remission (ceramic, white).  
 4) With fixed sensitivity adjustment and averaging setting = 1. With automatic sensitivity and measuring rate 500 μs: 2 ... 7.5 ms response time/measuring rate 1,000 μs: 4 ... 15 ms response time.  
 5) Wavelength: 655 nm, max. output: 390 μW (laser class 1) / < 1 mW (laser class 2).

## Interfaces

<b>Serial</b>	✓ , RS-485
<b>PROFIBUS DP</b>	✓
Type of fieldbus integration	Optional, over external evaluation unit AOD1 and Gateway WI180C-PB
<b>Digital output</b>	
Number	1 ... 3 <sup>1)</sup>
Type	PNP/NPN, selectable
<b>Analog output</b>	
Number	1 <sup>1)</sup>
Type	Current output
Current	4 mA ... 20 mA, ≤ 300 Ω

- 1) Optional over evaluation unit AOD1.

## Electronics

<b>Supply voltage U<sub>B</sub></b>	DC 12 V (-5 %) ... DC 24 V (+10 %)
<b>Power consumption</b>	≤ 1.92 W <sup>1)</sup>
<b>Warm-up time</b>	≤ 5 min
<b>Indication</b>	4-digit 7-segment display (plus 4 LEDs for status display)
<b>Enclosure rating</b>	IP67
<b>Protection class</b>	III

- 1) Without load, with current output.

## Mechanics

<b>Dimensions (W x H x D)</b>	17.8 mm x 44.4 mm x 31 mm
<b>Control elements</b>	4 buttons
<b>Housing material</b>	Metal (Aluminum)
<b>Window material</b>	Plastic (PPSU)
<b>Weight</b>	40 g
<b>Connection type</b>	Male connector, M8, 4-pin

## Ambient data

<b>Ambient temperature, operation</b>	-10 °C ... +50 °C
<b>Ambient temperature, storage</b>	-20 °C ... +60 °C
<b>Min. rel. humidity (not condensing)</b>	35 %
<b>Max. rel. humidity (not condensing)</b>	95 %
<b>Temperature drift</b>	± 0.08 % FS/K (FS = Full Scale = Measuring range of sensor)

<b>Typ. Ambient light immunity</b>	Artificial light: ≤ 3,000 lx Sunlight: ≤ 10,000 lx
<b>Vibration resistance</b>	10 Hz ... 55 Hz (amplitude 1.5 mm, x-, y-, z-axis 2 hours each)
<b>Shock resistance</b>	50 G (x, y, z axis 3 times each)

Certificates

<b>EU declaration of conformity</b>	✓
<b>UK declaration of conformity</b>	✓
<b>ACMA declaration of conformity</b>	✓
<b>Moroccan declaration of conformity</b>	✓
<b>China RoHS</b>	✓
<b>Information according to Art. 3 of Data Act (Regulation EU 2023/2854)</b>	✓

Classifications

<b>ECLASS 5.0</b>	27270801
<b>ECLASS 5.1.4</b>	27270801
<b>ECLASS 6.0</b>	27270801
<b>ECLASS 6.2</b>	27270801
<b>ECLASS 7.0</b>	27270801
<b>ECLASS 8.0</b>	27270801
<b>ECLASS 8.1</b>	27270801
<b>ECLASS 9.0</b>	27270801
<b>ECLASS 10.0</b>	27270801
<b>ECLASS 11.0</b>	27270801
<b>ECLASS 12.0</b>	27270916
<b>ETIM 5.0</b>	EC001825
<b>ETIM 6.0</b>	EC001825
<b>ETIM 7.0</b>	EC001825
<b>ETIM 8.0</b>	EC001825
<b>UNSPSC 16.0901</b>	41111613

### Dimensional drawing Aluminum housing

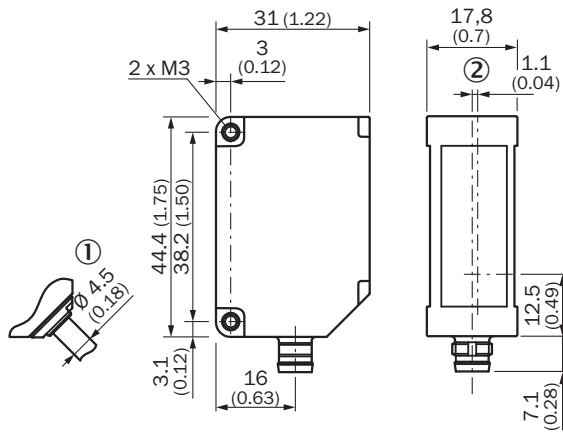

Dimensions in mm (inch)

- ① variant with 30 cm cable with M12, 5-pin connector
- ② Optical axis

### Connection type

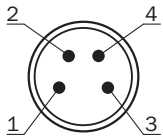

### Connection diagram

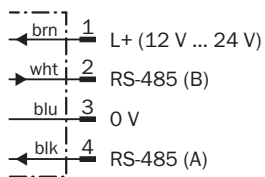

### Adjustments

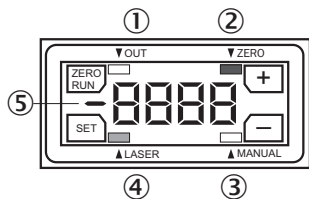

- ① digital output status indicator
- ② Zero offset status indicator
- ③ Teach mode status indicator
- ④ Laser status indicator
- ⑤ Minus sign for measured value indicator

### Linearity

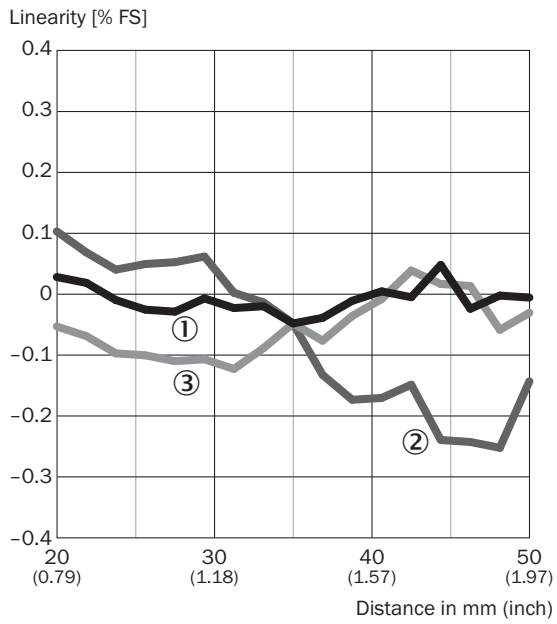







- ① White ceramic
- ② stainless steel
- ③ black rubber

## Recommended accessories

Other models and accessories → [www.sick.com/OD\\_Mini](http://www.sick.com/OD_Mini)

	Brief description	Type	part no.
<b>connectors and cables</b>			
	<ul style="list-style-type: none"> <li><b>Connection type head A:</b> Female connector, M8, 4-pin, straight</li> <li><b>Connection type head B:</b> Male connector, M8, 4-pin, straight</li> <li><b>Cable:</b> 2 m, PUR</li> </ul>	DSL-0804-G02MB	6059742
	<ul style="list-style-type: none"> <li><b>Connection type head A:</b> Female connector, M8, 4-pin, straight, A-coded</li> <li><b>Connection type head B:</b> Male connector, M8, 4-pin, straight, A-coded</li> <li><b>Signal type:</b> Sensor/actuator cable</li> <li><b>Cable:</b> 2 m, 4-wire, PUR, halogen-free</li> <li><b>Description:</b> Sensor/actuator cable, unshielded</li> <li><b>Application:</b> Uncontaminated zones, Zones with oils and lubricants, Robot, Drag chain operation</li> </ul>	YF8U14-020UA3M8U14	2096347
	<ul style="list-style-type: none"> <li><b>Connection type head A:</b> Female connector, M8, 4-pin, straight, A-coded</li> <li><b>Connection type head B:</b> Flying leads</li> <li><b>Signal type:</b> Sensor/actuator cable</li> <li><b>Cable:</b> 2 m, 4-wire, PUR, halogen-free</li> <li><b>Description:</b> Sensor/actuator cable, unshielded</li> <li><b>Application:</b> Uncontaminated zones, Zones with oils and lubricants, Robot, Drag chain operation</li> </ul>	YF8U14-020UA3XLEAX	2094791
	<ul style="list-style-type: none"> <li><b>Connection type head A:</b> Female connector, M8, 4-pin, angled, A-coded</li> <li><b>Connection type head B:</b> Flying leads</li> <li><b>Signal type:</b> Sensor/actuator cable</li> <li><b>Cable:</b> 2 m, 4-wire, PUR, halogen-free</li> <li><b>Description:</b> Sensor/actuator cable, unshielded</li> <li><b>Application:</b> Uncontaminated zones, Zones with oils and lubricants, Robot, Drag chain operation</li> </ul>	YG8U14-020UA3XLEAX	2095589
	<ul style="list-style-type: none"> <li><b>Connection type head A:</b> Female connector, M8, 4-pin, straight, A-coded</li> <li><b>Connection type head B:</b> Flying leads</li> <li><b>Signal type:</b> Sensor/actuator cable</li> <li><b>Cable:</b> 0.6 m, 4-wire, PUR, halogen-free</li> <li><b>Description:</b> Sensor/actuator cable, unshielded</li> <li><b>Application:</b> Uncontaminated zones, Zones with oils and lubricants, Robot, Drag chain operation</li> </ul>	YF8U14-C60UA3XLEAX	2145825
	<ul style="list-style-type: none"> <li><b>Connection type head A:</b> Female connector, M8, 4-pin, straight, A-coded</li> <li><b>Connection type head B:</b> Flying leads</li> <li><b>Signal type:</b> Sensor/actuator cable</li> <li><b>Cable:</b> 1 m, 4-wire, PUR, halogen-free</li> <li><b>Description:</b> Sensor/actuator cable, unshielded</li> <li><b>Application:</b> Uncontaminated zones, Zones with oils and lubricants, Robot, Drag chain operation</li> </ul>	YF8U14-010UA3XLEAX	2145826
<b>Mounting systems</b>			
	<ul style="list-style-type: none"> <li><b>Description:</b> Mounting bracket, no alignment bracket</li> <li><b>Material:</b> Stainless steel</li> <li><b>Details:</b> Stainless steel</li> </ul>	BEF-OD1-B	5328344
	<ul style="list-style-type: none"> <li><b>Description:</b> Mounting bracket, for wall installation, no alignment bracket</li> <li><b>Material:</b> Stainless steel</li> <li><b>Details:</b> Stainless steel</li> </ul>	BEF-OD1-A	5328343

	Brief description	Type	part no.
integration modules and adapters			
	<ul style="list-style-type: none"> <li><b>Description:</b> OD Mini evaluation unit, master, 1 x Q, M8 male connector, 4-pin</li> </ul>	AOD1-MR24Q1	6054270
	<ul style="list-style-type: none"> <li><b>Description:</b> OD Mini evaluation unit, slave, 1 x Q, M8 male connector, 4-pin</li> </ul>	AOD1-SR24Q1	6054271
	<ul style="list-style-type: none"> <li><b>Description:</b> OD Mini evaluation unit, master, 2 x Q, M12 male connector, 5-pin</li> </ul>	AOD1-MR25Q2	6054272
	<ul style="list-style-type: none"> <li><b>Description:</b> OD Mini evaluation unit, slave, 2 x Q, M12 male connector, 5-pin</li> </ul>	AOD1-SR25Q2	6054273
	<ul style="list-style-type: none"> <li><b>Description:</b> OD Mini evaluation unit, OD5000 and OL1, master, 3 x Q, 1 x analog, open end cable, 2 m</li> </ul>	AOD1-MR27C4	6058195
	<ul style="list-style-type: none"> <li><b>Description:</b> OD Mini evaluation unit, OD5000 and OL1, slave, 3 x Q, 1 x analog, open end cable, 2 m</li> </ul>	AOD1-SR27C4	6058196

## SICK AT A GLANCE

SICK is one of the leading manufacturers of intelligent sensors and sensor solutions for industrial applications. A unique range of products and services creates the perfect basis for controlling processes securely and efficiently, protecting individuals from accidents and preventing damage to the environment.

We have extensive experience in a wide range of industries and understand their processes and requirements. With intelligent sensors, we can deliver exactly what our customers need. In application centers in Europe, Asia and North America, system solutions are tested and optimized in accordance with customer specifications. All this makes us a reliable supplier and development partner.

Comprehensive services complete our offering: SICK LifeTime Services provide support throughout the machine life cycle and ensure safety and productivity.

For us, that is “Sensor Intelligence.”

## WORLDWIDE PRESENCE:

Contacts and other locations –[www.sick.com](http://www.sick.com)