



RMS1731C-636511

RMS1000

RADAR SENSORS

SICK
Sensor Intelligence.



Ordering information

Type	part no.
RMS1731C-636511	1125718

Other models and accessories → www.sick.com/RMS1000



Detailed technical data

Features

Application	Outdoor, Indoor	
Variant	Model RMS-E	
Measurement principle	FMCW	
Radio approval	New Zealand Canada USA	
Frequency band	61 GHz ... 61.5 GHz	
Transmitting power	< 20 dBm (e.i.r.p.)	
Aperture angle	Horizontal	± 60°
	Vertical	± 4°
Working range	0.4 m ... 100 m	
Scanning range	For 1 m ² RCS	50 m
	At 10 m ² RCS	100 m
Distance accuracy	1 m ² RCS to 20 m	0.04 m
	1 m ² RCS to 50 m	0.1 m
Distance resolution	0.4 m ¹⁾	
Speed range	± 30 m/s	
Speed resolution	0.625 m/s ¹⁾	
Speed accuracy	1 m ² RCS to 20 m	0.0625 m/s
	1 m ² RCS to 50 m	0.15 m/s

¹⁾ Resolution in the context of radar means that two signals can be separated if they differ in spacing, angle or speed by more than twice the specified values.

Mechanics/electronics

Connection type	1 x M12 male connector, 8-pin, A-coded 1 x male connector M12, 5-pin, A-coded
------------------------	--

	1 x M12 female connector, 4-pin, D-coded
Supply voltage	9 V DC ... 32 V DC
Power consumption	Typ. 4 W, For digital outputs without load, max. 36 W
Housing color	Gray (RAL 7042)
Enclosure rating	IP67 IP69
Protection class	III
Weight	300 g
Dimensions (L x W x H)	34 mm x 97 mm x 96 mm
MTBF	81 years

Safety-related parameters

MTTF_D	> 100 years
-------------------------	-------------

Performance

Initialization time	Typ. 20 s
Processing latency	1 measurement cycle
Measurement cycle duration	100 ms
Integrated application	Zone evaluation
Number of field sets	Up to 4 zones

Interfaces

Ethernet	✓
Function	Parameterization, Data output
Data transmission rate	10/100 MBit/s
CAN	
Remark	Future option, hardware built into product
Digital inputs	2 (digital)
Digital outputs	4 (digital)

Ambient data

Electromagnetic compatibility (EMC)	ETSI EN 301 489-1 / EN 61000-6-2 / EN 61000-6-4
Radio standard	ETSI EN 305 550
Vibration resistance	EN 60068-2-6:2008-02
Shock resistance	EN 60068-2-27:2009-05
Ambient operating temperature	-40 °C ... +65 °C
Storage temperature	-40 °C ... +85 °C

Certificates

FCC certificate	✓
Radio Approval certificate	✓
Radio Approval certificate New Zealand	✓

Classifications

ECLASS 5.0	27270890
ECLASS 5.1.4	27270890

ECLASS 6.0	27270890
ECLASS 6.2	27270890
ECLASS 7.0	27270890
ECLASS 8.0	27270890
ECLASS 8.1	27270890
ECLASS 9.0	27270890
ECLASS 10.0	27270807
ECLASS 11.0	27270807
ECLASS 12.0	27274501
ETIM 5.0	EC001825
ETIM 6.0	EC001825
ETIM 7.0	EC001825
ETIM 8.0	EC001825
UNSPSC 16.0901	39121528

Dimensional drawing

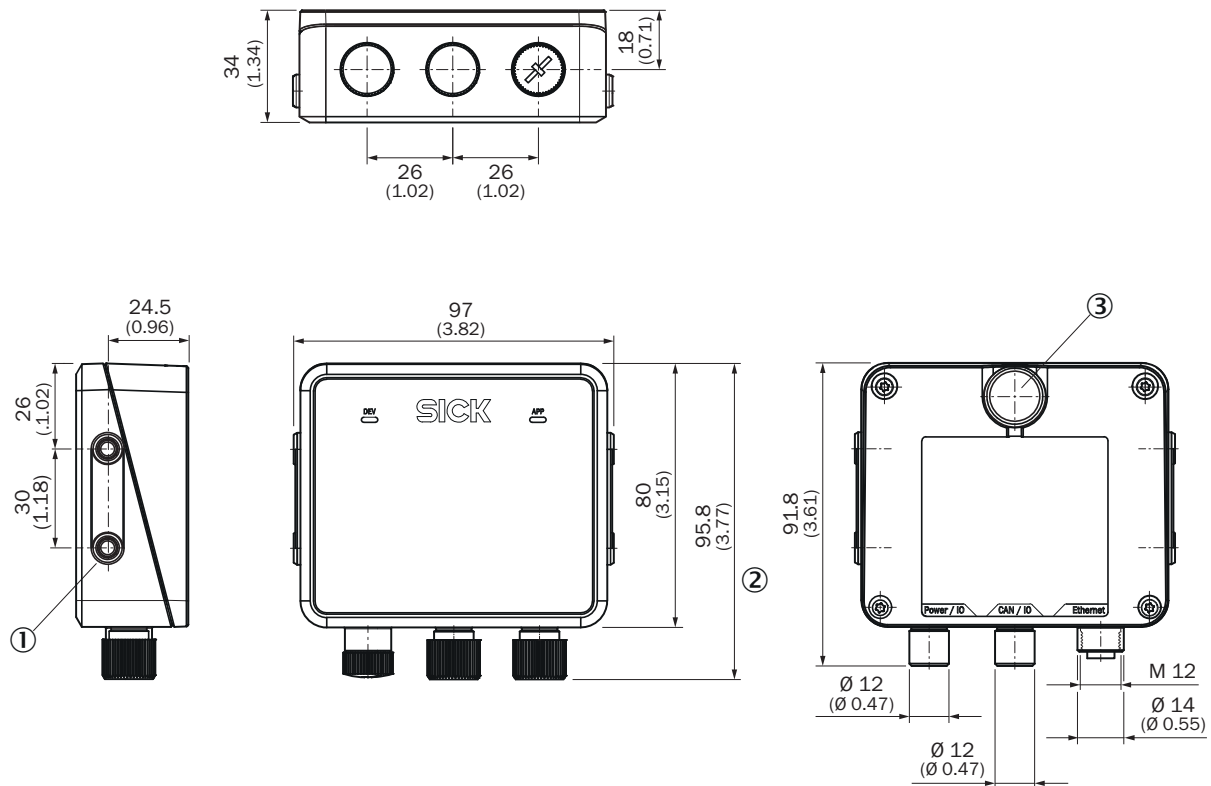

Dimensions in mm (inch)

structure and device dimensions, unit: mm (inch), decimal separator: period

- ① 4 x M5 blind tapped holes, 7.5 mm deep for mounting the device
- ② Dimension with protective cap mounted on the connections
- ③ Pressure compensation diaphragm

PIN assignment CAN

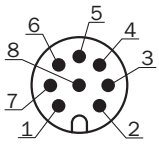

Connector M12, 8-pin, A-coded

- ① CAN_H
- ② CAN_L
- ③ In₂
- ④ GND IN1/2
- ⑤ OUT2
- ⑥ OUT3
- ⑦ GND
- ⑧ OUT4

PIN assignment Ethernet

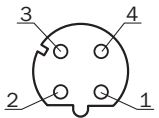

M12 female connector, 4-pin, D-coded

- ① TX+
- ② RX+
- ③ TX-
- ④ RX-

PIN assignment Power

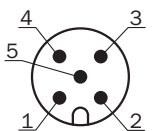















Connector M12, 5-pin, A-coded

- ① L+
- ② In₁
- ③ GND
- ④ OUT1
- ⑤ GND IN1/2

Recommended accessories

Other models and accessories → www.sick.com/RMS1000

	Brief description	Type	part no.
connectors and cables			
	<ul style="list-style-type: none"> Connection type head A: Male connector, M12, 4-pin, angled, D-coded Connection type head B: Male connector, RJ45, 8-pin, straight Signal type: Ethernet Cable: 5 m, 4-wire, CAT5, CAT5e, PUR, halogen-free Description: Ethernet, shielded 	SSL-2J04-H05ME	6045287
	<ul style="list-style-type: none"> Connection type head A: Female connector, M12, 5-pin, straight, A-coded Connection type head B: Flying leads Signal type: Sensor/actuator cable Cable: 5 m, 5-wire, PUR, halogen-free Description: Sensor/actuator cable, shielded Application: Uncontaminated zones, Zones with oils and lubricants, Robot, Drag chain operation 	YF2A25-050UB6XLEAX	2095733
	<ul style="list-style-type: none"> Connection type head A: Female connector, M12, 5-pin, angled, A-coded Connection type head B: Flying leads Signal type: Sensor/actuator cable Cable: 5 m, 5-wire, PUR, halogen-free Description: Sensor/actuator cable, shielded Application: Uncontaminated zones, Zones with oils and lubricants, Robot, Drag chain operation 	YG2A25-050UB6XLEAX	2095792
	<ul style="list-style-type: none"> Connection type head A: Male connector, M12, 4-pin, straight, D-coded Connection type head B: Male connector, RJ45, 4-pin, straight Signal type: Ethernet, PROFINET Cable: 5 m, 4-wire, PUR, halogen-free Description: Ethernet, shielded, PROFINET Application: Drag chain operation, Zones with oils and lubricants 	YM2D24-050P-N1MRJA4	2106184
	<ul style="list-style-type: none"> Connection type head A: Female connector, M12, 8-pin, straight, A-coded Connection type head B: Flying leads Signal type: Sensor/actuator cable Cable: 5 m, 8-wire, PUR, halogen-free Description: Sensor/actuator cable, unshielded Application: Uncontaminated zones, Zones with oils and lubricants, Robot, Drag chain operation 	YF2A18-050UA5XLEAX	2095653
	<ul style="list-style-type: none"> Connection type head A: Female connector, M12, 8-pin, angled, A-coded Connection type head B: Flying leads Signal type: Sensor/actuator cable Cable: 2 m, 8-wire, PUR, halogen-free Description: Sensor/actuator cable, unshielded Application: Uncontaminated zones, Zones with oils and lubricants, Robot, Drag chain operation 	YG2A18-020UA5XLEAX	2095779
	<ul style="list-style-type: none"> Connection type head A: Female connector, M12, 5-pin, straight, A-coded Connection type head B: Flying leads Signal type: Sensor/actuator cable Cable: 2 m, 5-wire, PUR, halogen-free Description: Sensor/actuator cable, shielded Application: Uncontaminated zones, Zones with oils and lubricants, Robot, Drag chain operation 	YF2A25-020UB6XLEAX	2145583
	<ul style="list-style-type: none"> Connection type head A: Female connector, M12, 5-pin, straight, A-coded Connection type head B: Flying leads Signal type: Sensor/actuator cable Cable: 1 m, 5-wire, PUR, halogen-free Description: Sensor/actuator cable, shielded Application: Uncontaminated zones, Zones with oils and lubricants, Robot, Drag chain operation 	YF2A25-010UB6XLEAX	2145582
	<ul style="list-style-type: none"> Connection type head A: Female connector, M12, 5-pin, straight, A-coded Connection type head B: Flying leads Signal type: Sensor/actuator cable Cable: 0.6 m, 5-wire, PUR, halogen-free Description: Sensor/actuator cable, shielded Application: Uncontaminated zones, Zones with oils and lubricants, Robot, Drag chain operation 	YF2A25-C60UB6XLEAX	2145581
	<ul style="list-style-type: none"> Connection type head A: Female connector, M12, 8-pin, angled, A-coded Connection type head B: Flying leads Signal type: Sensor/actuator cable Cable: 0.6 m, 8-wire, PUR, halogen-free Description: Sensor/actuator cable, unshielded Application: Uncontaminated zones, Zones with oils and lubricants, Robot, Drag chain operation 	YG2A18-C60UA5XLEAX	2145381
	<ul style="list-style-type: none"> Connection type head A: Female connector, M12, 8-pin, angled, A-coded Connection type head B: Flying leads Signal type: Sensor/actuator cable Cable: 1 m, 8-wire, PUR, halogen-free Description: Sensor/actuator cable, unshielded 	YG2A18-010UA5XLEAX	2145382

	Brief description	Type	part no.
	<ul style="list-style-type: none"> • Application: Uncontaminated zones, Zones with oils and lubricants, Robot, Drag chain operation • Connection type head A: Female connector, M12, 8-pin, angled, A-coded • Connection type head B: Flying leads • Signal type: Sensor/actuator cable • Cable: 3 m, 8-wire, PUR, halogen-free • Description: Sensor/actuator cable, unshielded • Application: Uncontaminated zones, Zones with oils and lubricants, Robot, Drag chain operation 	YG2A18-030UA5XLEAX	2145383
	<ul style="list-style-type: none"> • Connection type head A: Female connector, M12, 5-pin, angled, A-coded • Connection type head B: Flying leads • Signal type: Sensor/actuator cable • Cable: 0.6 m, 5-wire, PUR, halogen-free • Description: Sensor/actuator cable, shielded • Application: Uncontaminated zones, Zones with oils and lubricants, Robot, Drag chain operation 	YG2A25-C60UB6XLEAX	2145612
	<ul style="list-style-type: none"> • Connection type head A: Female connector, M12, 5-pin, angled, A-coded • Connection type head B: Flying leads • Signal type: Sensor/actuator cable • Cable: 1 m, 5-wire, PUR, halogen-free • Description: Sensor/actuator cable, shielded • Application: Uncontaminated zones, Zones with oils and lubricants, Robot, Drag chain operation 	YG2A25-010UB6XLEAX	2145613
	<ul style="list-style-type: none"> • Connection type head A: Female connector, M12, 5-pin, angled, A-coded • Connection type head B: Flying leads • Signal type: Sensor/actuator cable • Cable: 2 m, 5-wire, PUR, halogen-free • Description: Sensor/actuator cable, shielded • Application: Uncontaminated zones, Zones with oils and lubricants, Robot, Drag chain operation 	YG2A25-020UB6XLEAX	2145614

SICK AT A GLANCE

SICK is one of the leading manufacturers of intelligent sensors and sensor solutions for industrial applications. A unique range of products and services creates the perfect basis for controlling processes securely and efficiently, protecting individuals from accidents and preventing damage to the environment.

We have extensive experience in a wide range of industries and understand their processes and requirements. With intelligent sensors, we can deliver exactly what our customers need. In application centers in Europe, Asia and North America, system solutions are tested and optimized in accordance with customer specifications. All this makes us a reliable supplier and development partner.

Comprehensive services complete our offering: SICK LifeTime Services provide support throughout the machine life cycle and ensure safety and productivity.

For us, that is “Sensor Intelligence.”

WORLDWIDE PRESENCE:

Contacts and other locations –www.sick.com