



IM12-04NDS-ZW1

IM Standard

INDUCTIVE PROXIMITY SENSORS

SICK
Sensor Intelligence.



Illustration may differ



Ordering information

Type	part no.
IM12-04NDS-ZW1	6020314

Other models and accessories → www.sick.com/IM_Standard

Detailed technical data

Features

Housing	Metric
Housing	Standard design
Thread size	M12 x 1
Diameter	Ø 12 mm
Sensing range S_n	4 mm
Safe sensing range S_a	3.24 mm
Installation type	Non-flush
Switching frequency	1,500 Hz
Connection type	Cable, 2-wire, 2 m
Output function	NO
Electrical wiring	DC 2-wire
Enclosure rating	IP67 ¹⁾

¹⁾ According to EN 60529.

Mechanics/electronics

Supply voltage	10 V DC ... 30 V DC
Ripple	≤ 10 %
Voltage drop	≤ 2.8 V ¹⁾
Time delay before availability	≤ 50 ms
Hysteresis	2 % ... 10 %
Reproducibility	≤ 5 % ²⁾ ³⁾

¹⁾ At I_a max.

²⁾ Supply voltage U_B and constant ambient temperature T_a .

³⁾ Of S_r .

Temperature drift (of S_r)	± 10 %
EMC	According to EN 60947-5-2
Continuous current I_a	≤ 100 mA
Off-state current	≤ 0.8 mA
Minimum load current	≥ 3 mA
Cable material	PVC
Conductor size	0.22 mm ²
Short-circuit protection	✓
Shock and vibration resistance	30 g, 11 ms / 10 ... 55 Hz, 1 mm
Ambient operating temperature	-25 °C ... +70 °C
Housing material	Brass, Nickel-plated brass
Sensing face material	Plastic
Housing length	60 mm
Thread length	45 mm
Tightening torque, max.	10 Nm

¹⁾ At I_a max.

²⁾ Supply voltage U_B and constant ambient temperature T_a.

³⁾ Of S_r.

Safety-related parameters

MTTF_D	192 years
DC_{avg}	0 %

Reduction factors

Note	The values are reference values which may vary
Stainless steel (V2A, 304)	Approx. 0.87
Aluminum (Al)	Approx. 0.57
Copper (Cu)	Approx. 0.52
Brass (Br)	Approx. 0.62

Installation note

Remark	Associated graphic see "Installation"
A	12 mm
B	24 mm
C	12 mm
D	12 mm
E	6 mm
F	32 mm

Certificates

EU declaration of conformity	✓
UK declaration of conformity	✓
Moroccan declaration of conformity	✓
China RoHS	✓

Classifications

ECLASS 5.0	27270101
ECLASS 5.1.4	27270101
ECLASS 6.0	27270101
ECLASS 6.2	27270101
ECLASS 7.0	27270101
ECLASS 8.0	27270101
ECLASS 8.1	27270101
ECLASS 9.0	27270101
ECLASS 10.0	27270101
ECLASS 11.0	27270101
ECLASS 12.0	27274001
ETIM 5.0	EC002714
ETIM 6.0	EC002714
ETIM 7.0	EC002714
ETIM 8.0	EC002714
UNSPSC 16.0901	39122230

Installation note Non-flush installation

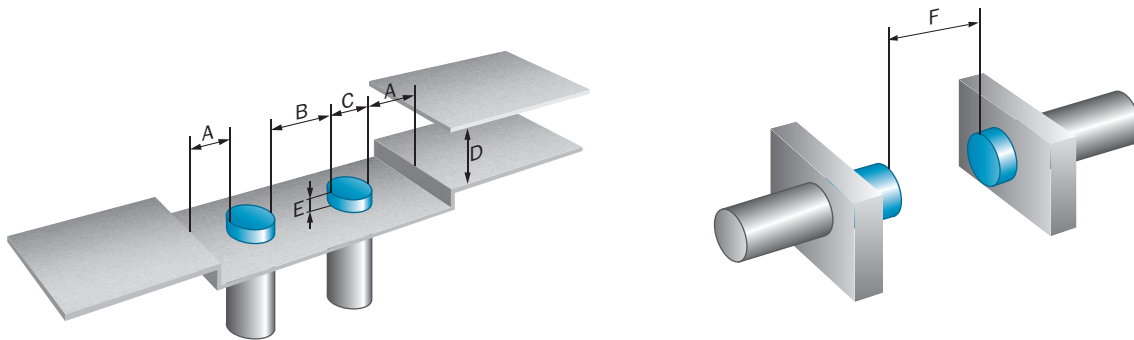

Connection type

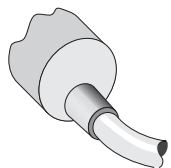

Connection diagram Cd-012

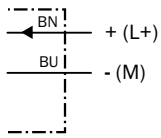

Dimensional drawing IM12, DC, cable, non-flush

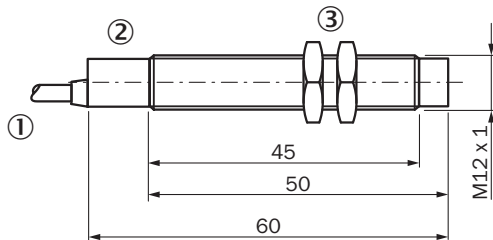





Dimensions in mm (inch)

- ① Connection
- ② Display LED
- ③ Fastening nuts (2x); width across 17, metal

Recommended accessories

Other models and accessories → www.sick.com/IM_Standard

	Brief description	Type	part no.
Mounting systems			
	<ul style="list-style-type: none"> • Description: Clamping block for round sensors M12, with fixed stop • Material: Plastic • Details: Plastic (PA12), glass-fiber reinforced • Items supplied: Mounting hardware included 	BEF-KHF-M12	2051480
	<ul style="list-style-type: none"> • Description: Clamping block for round sensors M12, without fixed stop • Material: Plastic • Details: Plastic (PA12), glass-fiber reinforced • Items supplied: Mounting hardware included 	BEF-KH-M12	2051479
	<ul style="list-style-type: none"> • Description: Mounting plate for M12 sensors • Material: Steel • Details: Steel, zinc coated • Items supplied: Without mounting hardware 	BEF-WG-M12	5321869
	<ul style="list-style-type: none"> • Description: Mounting bracket for M12 sensors • Material: Steel • Details: Steel, zinc coated • Items supplied: Without mounting hardware 	BEF-WN-M12	5308447

	Brief description	Type	part no.
connectors and cables			
	<ul style="list-style-type: none">• Connection type head A: Male connector, M8, 3-pin, straight, A-coded• Description: Unshielded• Connection systems: Screw-type terminals• Permitted cross-section: 0.14 mm² ... 0.5 mm²	STE-0803-G	6037322

SICK AT A GLANCE

SICK is one of the leading manufacturers of intelligent sensors and sensor solutions for industrial applications. A unique range of products and services creates the perfect basis for controlling processes securely and efficiently, protecting individuals from accidents and preventing damage to the environment.

We have extensive experience in a wide range of industries and understand their processes and requirements. With intelligent sensors, we can deliver exactly what our customers need. In application centers in Europe, Asia and North America, system solutions are tested and optimized in accordance with customer specifications. All this makes us a reliable supplier and development partner.

Comprehensive services complete our offering: SICK LifeTime Services provide support throughout the machine life cycle and ensure safety and productivity.

For us, that is “Sensor Intelligence.”

WORLDWIDE PRESENCE:

Contacts and other locations –www.sick.com