

EDM35-2KF0A020A-40

EDS/EDM35-S

SAFE MOTOR FEEDBACK SYSTEMS

SICK
Sensor Intelligence.

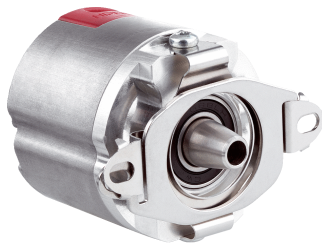

Illustration may differ



Ordering information

Type	part no.
EDM35-2KF0A020A-40	1112143

Included in delivery: EDM35-2KF0A020A (1)

Other models and accessories → www.sick.com/EDS_EDM35-S

Detailed technical data

Features

Items supplied	Mounting screws M3 for stator coupling not included with delivery. Safe motor feedback system EDM35-2KF0A020A (1090711). Packaging unit 40 pcs., Operating instructions (part number: 8022479), 1 pc. per packaging unit., General safety notes (part number: 8014060), 1 pc. per packaging unit.
-----------------------	---

Safety-related parameters

Safety integrity level	SIL 2 (IEC 61508), SILCL3 (IEC 62061) ¹⁾
Category	3 (EN ISO 13849-1:2015)
Systematic suitability	SC 3 (IEC61508)
Test rate	24 h
Maximum demand rate	216 µs
Performance level	PL d (EN ISO 13849-1:2015)
Basis for safety function	Safe singleturn absolute position
Safety-related resolution	13 bits
Maximum difference between Safe Position 1 and Safe Position 2	3 increments
PFH (mean probability of a dangerous failure per hour)	33×10^{-9} ²⁾
T_M (mission time)	20 years
Safety-related accuracy	0.135° ³⁾

¹⁾ For more detailed information on the exact configuration of your machine/unit, please consult your relevant SICK branch office.

²⁾ At 60 °C ambient temperature.

³⁾ The safety-related accuracy indicates the maximum positioning error limit with which the safety functions can be supported.

Performance

Position	
Resolution per revolution	20 bit
System accuracy	$\pm 50''$ ¹⁾

¹⁾ In accordance with DIN ISO 1319-1, position of the upper and lower error limit depends on the installation situation, specified value refers to a symmetrical position, i.e. deviation in upper and lower direction is the same.

²⁾ Repeatability standard deviation in accordance with DIN 1319-1:1995.

Signal noise (σ)	± 3 " ²⁾
Number of the absolute ascertainable revolutions	4,096
Available memory area	8,192 Byte
Measurement principle	Optical

¹⁾ In accordance with DIN ISO 1319-1, position of the upper and lower error limit depends on the installation situation, specified value refers to a symmetrical position, i.e. deviation in upper and lower direction is the same.

²⁾ Repeatability standard deviation in accordance with DIN 1319-1:1995.

Interfaces

Code sequence	Increasing, when turning the shaft For clockwise rotation, looking in direction "A" (see dimensional drawing)
Communication interface	HIPERFACE DSL [®]
Initialization time	≤ 500 ms ¹⁾
Measurement external temperature resistance	32-bit value, without prefix (1 Ω) 0 ... 209.600 Ω ²⁾

¹⁾ From reaching a permitted operating voltage.

²⁾ Without sensor tolerance; at -40 °C ... $+160$ °C: NTC $+2K$; PTC $+3K$ (KTY84-130/PT1000). For additional conversion function of PT1000 to KTY84/130, see technical description.

Electronics

Connection type	Male connector, 4-pin
Supply voltage	7 V ... 12 V
Warm-up time voltage ramp	Max. 180 ms ¹⁾
Current consumption	≤ 150 mA ²⁾

¹⁾ Duration of voltage ramp between 0 and 7.0 V.

²⁾ Current rating applies when using interface circuit suggestions as shown in HIPERFACE DSL[®] manual (8017595).

Mechanics

Shaft version	Tapered shaft
Flange type / stator coupling	Stator coupling
Dimensions	See dimensional drawing
Weight	≤ 100 g
Moment of inertia of the rotor	5 gcm ²
Operating speed	$\leq 9,000$ min ⁻¹
Angular acceleration	$\leq 250,000$ rad/s ²
Start up torque	≤ 0.6 Ncm, $+20$ °C
Permissible movement static	± 1 mm axial ¹⁾
Permissible movement dynamic	± 0.025 mm radial ²⁾
Life of ball bearings	50,000 h at 6,000 min ⁻¹ (at a flange temperature of 70 °C)

¹⁾ Temperature expansion, mechanical attachment.

²⁾ For SIL2 version.

Ambient data

Operating temperature range	-40 °C ... +115 °C ¹⁾
Storage temperature range	-40 °C ... +125 °C, without package
Relative humidity/condensation	90 %, Condensation not permitted
Resistance to shocks	100 g, 6 ms (according to EN 60068-2-27)
Frequency range of resistance to vibrations	50 g, 10 Hz ... 2,000 Hz (EN 60068-2-6)
EMC	According to EN 61000-6-2: 2016, EN 61000-6-4: 2006, IEC 6100-6-7: 2014 ²⁾
Enclosure rating	IP40, When cover is closed and mating connector is attached (IEC 60529-1)

¹⁾ Given typical thermal connection between motor flange and encoder stator coupling. The max. internal sensor temperature may not exceed 125 °C.

²⁾ According to the listed standards, EMC is guaranteed if the motor feedback system with mating connector inserted is connected to the central grounding point of the motor controller via a cable shield. If other shielding concepts are used, users must perform their own tests. Class A device.

Certificates

EU declaration of conformity	✓
UK declaration of conformity	✓
ACMA declaration of conformity	✓
Moroccan declaration of conformity	✓
China-RoHS	✓
EC-Type-Examination approval	✓
Information according to Art. 3 of Data Act (Regulation EU 2023/2854)	✓

Classifications

ECLASS 5.0	27270590
ECLASS 5.1.4	27270590
ECLASS 6.0	27270590
ECLASS 6.2	27270590
ECLASS 7.0	27270590
ECLASS 8.0	27270590
ECLASS 8.1	27270590
ECLASS 9.0	27270590
ECLASS 10.0	27273805
ECLASS 11.0	27273901
ECLASS 12.0	27273901
ETIM 5.0	EC001486
ETIM 6.0	EC001486
ETIM 7.0	EC001486
ETIM 8.0	EC001486
UNSPSC 16.0901	41112113

Dimensional drawing

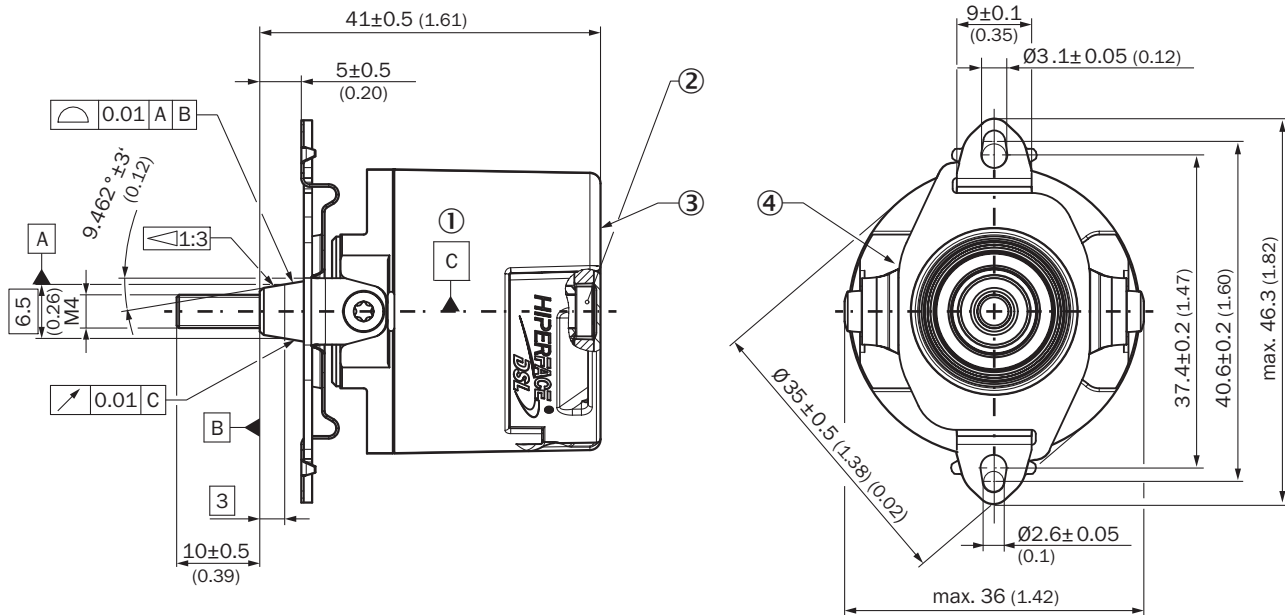

Dimensions in mm (inch)

- ① bearing of the encoder shaft
- ② torx 15 cylinder screw
- ③ measuring point for vibrations
- ④ Measuring point for operating temperature





PIN assignment Temperature sensor pin assignment



K connection type

Recommended accessories

Other models and accessories → www.sick.com/EDS_EDM35-S

	Brief description	Type	part no.
Mounting systems			
	<ul style="list-style-type: none"> Description: Screws with Precote 85-8 coating; M4*48 (4093779) Packing unit: 500 pieces 	BEF-MK-S09	2103244
	<ul style="list-style-type: none"> Description: Screws with Precote 85-8 coating; M4*48 (4093779) Packing unit: 100 pieces 	BEF-MK-S10	2103272
	<ul style="list-style-type: none"> Description: Screws with Precote 85-8 coating; M4*48 (4093779) Packing unit: 10 pieces 	BEF-MK-S11	2103274
connectors and cables			
	<ul style="list-style-type: none"> Connection type head A: Female connector, stranded wire, 4-pin, straight Connection type head B: Flying leads Signal type: HIPERFACE DSL[®] Cable: 0.36 m, 2-wire Description: HIPERFACE DSL[®], twisted, shielded 	DOL-0B02-G0M3AC2	2108944
	<ul style="list-style-type: none"> Connection type head A: Female connector, stranded wire, 4-pin, straight Connection type head B: Flying leads Signal type: HIPERFACE DSL[®] Cable: 0.2 m, 2-wire Description: HIPERFACE DSL[®], unshielded 	DOL-0B02-G0M2XC2	2079920

SICK AT A GLANCE

SICK is one of the leading manufacturers of intelligent sensors and sensor solutions for industrial applications. A unique range of products and services creates the perfect basis for controlling processes securely and efficiently, protecting individuals from accidents and preventing damage to the environment.

We have extensive experience in a wide range of industries and understand their processes and requirements. With intelligent sensors, we can deliver exactly what our customers need. In application centers in Europe, Asia and North America, system solutions are tested and optimized in accordance with customer specifications. All this makes us a reliable supplier and development partner.

Comprehensive services complete our offering: SICK LifeTime Services provide support throughout the machine life cycle and ensure safety and productivity.

For us, that is “Sensor Intelligence.”

WORLDWIDE PRESENCE:

Contacts and other locations –www.sick.com