



# V3DX3-002BR21A

Ruler3000

3D MACHINE VISION

**SICK**  
Sensor Intelligence.



### Ordering information

Type	part no.
V3DX3-002BR21A	1126985

Other models and accessories → [www.sick.com/Ruler3000](http://www.sick.com/Ruler3000)



### Detailed technical data

#### Features

<b>Technology</b>	3D triangulation
<b>Streaming</b>	✓
<b>Pre-calibrated</b>	✓
<b>Shutter technology</b>	Global-Shutter
<b>Working range</b>	46.7 mm ... 55.4 mm
<b>Example field of view</b>	25 mm x 6 mm
<b>Exposure mode</b>	Linear HDR
<b>Illumination</b>	Integrated
<b>Illumination color</b>	Blue, laser, Visible, 450 nm, ± 10 nm
<b>Laser class</b>	3R (EN 60825-1:2014+A11:2021; IEC 60825-1:2014, Complies with the FDA performance requirements for laser products except for conformance with IEC 60825-1 Ed.3., as described in Laser Notice 56 dated May 8, 2019.)
<b>Data synchronization</b>	Free running, encoder triggered, external triggering
<b>3D measurement</b>	✓
<b>Scatter measurement</b>	✓
<b>Reflectance measurement</b>	✓
<b>Ambient light suppression</b>	✓ <sup>1)</sup>
<b>Scheimpflug adapter, integrated</b>	✓
<b>Width at minimum operating distance</b>	25 mm
<b>Width at maximum operating distance</b>	26.6 mm
<b>Maximum height range</b>	8.7 mm

<sup>1)</sup> Blue bandpass filter.

<b>Task</b>	Detecting - Standard objects Detecting - Level Measuring - Dimension, contour and volume Monitoring and controlling - Quality Determining position - 3D position determination
-------------	--

<sup>1)</sup> Blue bandpass filter.

## Mechanics/electronics

<b>Connection type</b>	Voltage – I/O: M12, 17-pin male connector Gigabit Ethernet: M12, 8-pin socket, X-coded
<b>Connector material</b>	M12: Nickel-coated brass
<b>Supply voltage</b>	24 V DC, ± 10 %
<b>Ripple</b>	< 5 V <sub>pp</sub>
<b>Power consumption</b>	≤ 12 W
<b>Current consumption</b>	≤ 1.5 A
<b>Enclosure rating</b>	IP65 IP67
<b>Protection class</b>	III
<b>Housing material</b>	Aluminum
<b>Housing color</b>	Blue
<b>Window material</b>	Float glass, anti-reflective coated
<b>Weight</b>	1.08 kg
<b>Dimensions (L x W x H)</b>	154 mm x 60.3 mm x 100 mm

## Performance

<b>Image sensor</b>	CMOS sensor from SICK with ROCC technology, M30
<b>Scan/frame rate</b>	46,000 3D profiles/s, In reduced ROI 7,000 3D profiles/s, full format
<b>Data points/profile</b>	3,200
<b>Repeatability</b>	0.3 μm <sup>1)</sup>
<b>Typical resolution</b>	Z resolution (height): 0.8 μm ... 1 μm, X resolution (width): 11 μm ...12 μm

<sup>1)</sup> Height values measured for different positions in the field of view. 20 measurements are performed at each position. The repeatability value is the 3-fold of the standard deviation (3 σ) for all measurements at all positions.

## Interfaces

<b>Ethernet</b>	✓, UDP/IP
Remark	GigE Vision Standard
Data transmission rate	≤ 1 Gbit/s
<b>Configuration software</b>	Stream Setup
<b>Operating system</b>	Windows 10
<b>Application programming interface (API)</b>	GenAPI, GenTL, Proprietary SICK GenIStream
<b>Inputs/outputs</b>	4 x HIGH = 10 V ... 28.8 V, configurable
<b>Encoder interface</b>	RS-422 5 V, 2 x HTL single-ended

## Ambient data

<b>Shock load</b>	15 g, 3 cycles per axis
-------------------	-------------------------

<sup>1)</sup> Non-condensing.

<b>Vibration load</b>	5 g, 10 Hz ... 150 Hz (EN 60068-2-6)
<b>Ambient operating temperature</b>	0 °C ... +40 °C <sup>1)</sup>
<b>Storage temperature</b>	-30 °C ... +70 °C <sup>1)</sup>

<sup>1)</sup> Non-condensing.

### Classifications

<b>ECLASS 5.0</b>	27310205
<b>ECLASS 5.1.4</b>	27310205
<b>ECLASS 6.0</b>	27310205
<b>ECLASS 6.2</b>	27310205
<b>ECLASS 7.0</b>	27310205
<b>ECLASS 8.0</b>	27310205
<b>ECLASS 8.1</b>	27310205
<b>ECLASS 9.0</b>	27310205
<b>ECLASS 10.0</b>	27310205
<b>ECLASS 11.0</b>	27310205
<b>ECLASS 12.0</b>	27310205
<b>ETIM 5.0</b>	EC001820
<b>ETIM 6.0</b>	EC001820
<b>ETIM 7.0</b>	EC001820
<b>ETIM 8.0</b>	EC001820
<b>UNSPSC 16.0901</b>	43211731

### Certificates

<b>EU declaration of conformity</b>	✓
<b>UK declaration of conformity</b>	✓
<b>ACMA declaration of conformity</b>	✓
<b>China-RoHS</b>	✓
<b>cTUVus certificate</b>	✓
<b>Information according to Art. 3 of Data Act (Regulation EU 2023/2854)</b>	✓
<b>GigE Vision</b>	✓
<b>GenICam</b>	✓

## Dimensional drawing

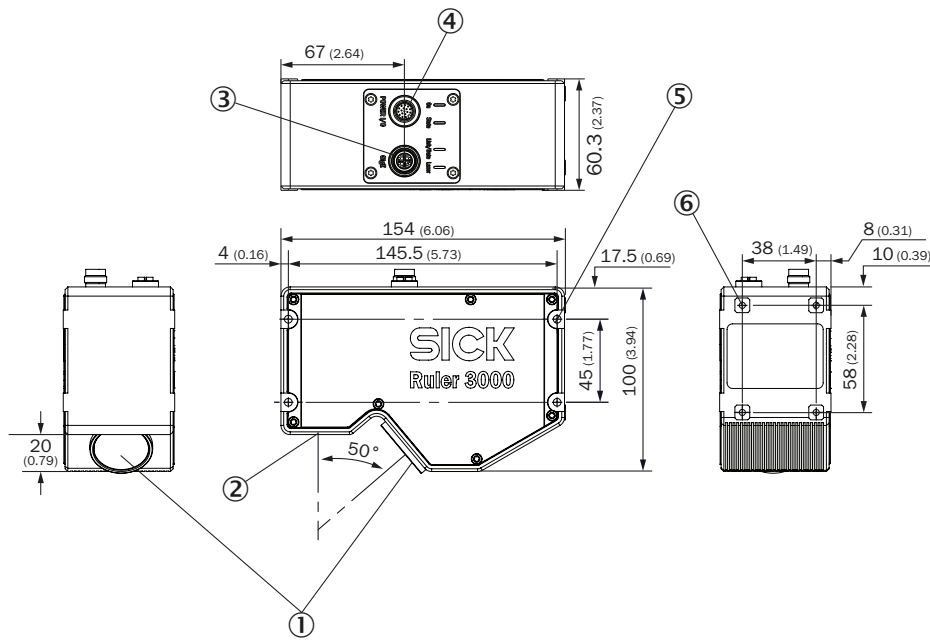

Dimensions in mm (inch)

- ① Optical receiver (center)
- ② Optical sender (center)
- ③ Gigabit Ethernet connection (GbE)
- ④ Power/I/O connection
- ⑤ Threaded mounting hole M5
- ⑥ M5 threaded mounting hole, 10 mm deep

Field of view

**Ruler3002**

Guaranteed field of view in mm

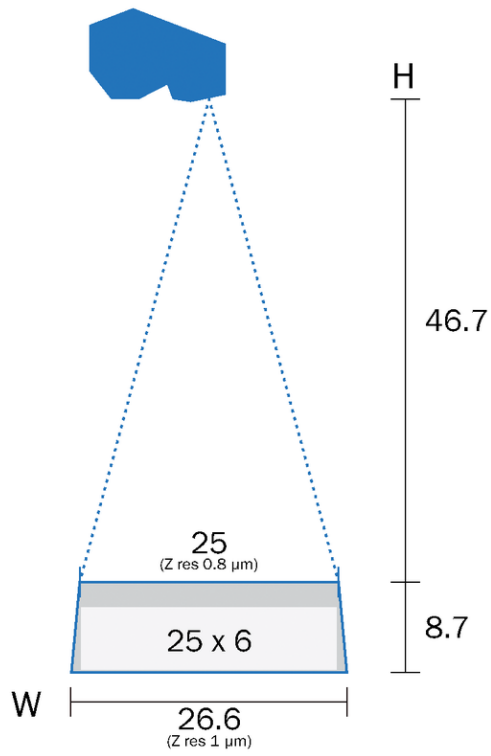

Characteristic curve Z resolution via Z position

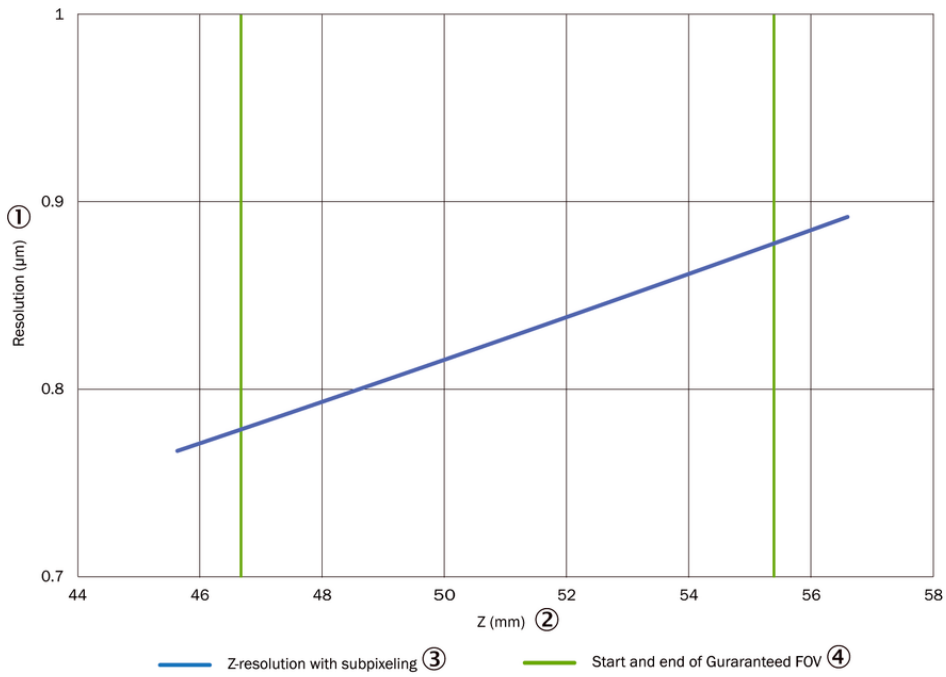

Characteristic curve Width of the field of view via the Z position

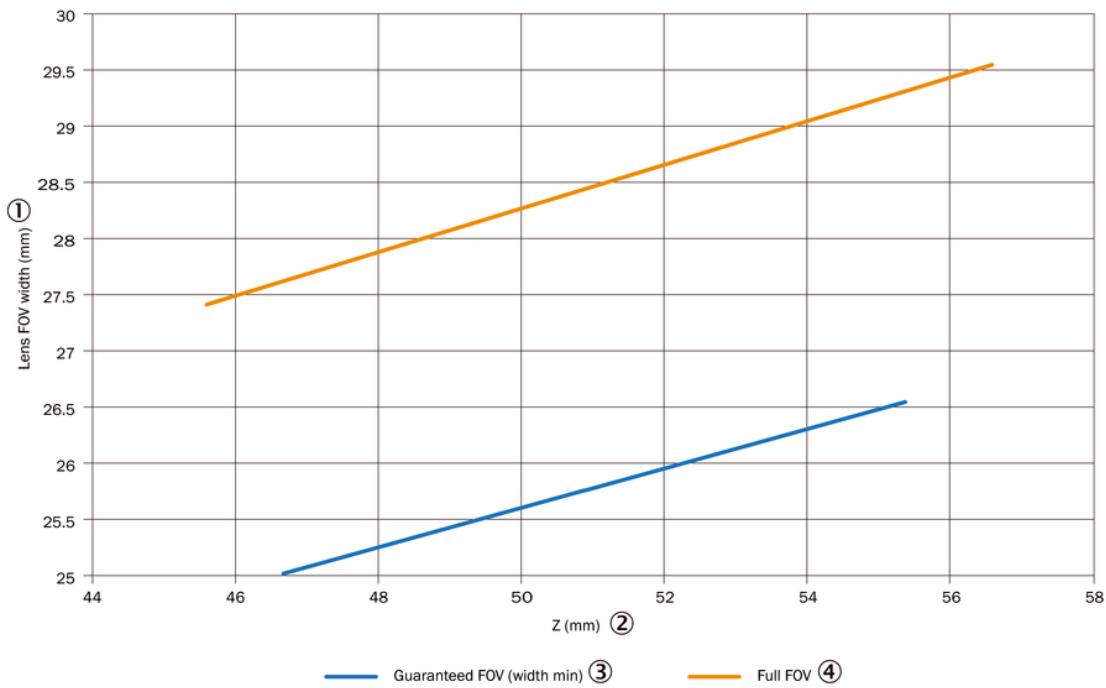

### Characteristic curve X resolution via Z position

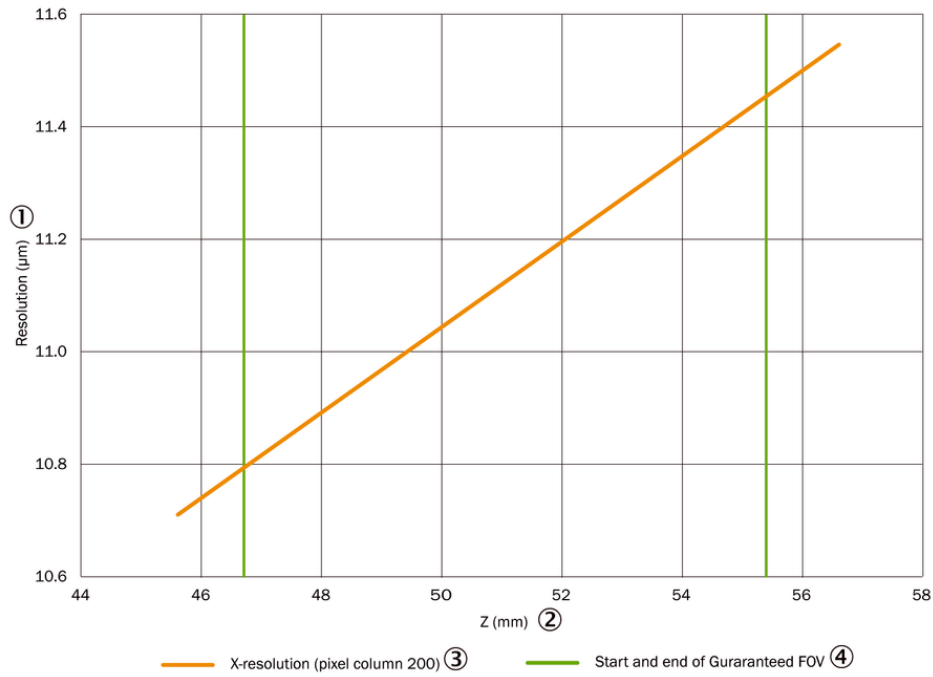

### Characteristic curve

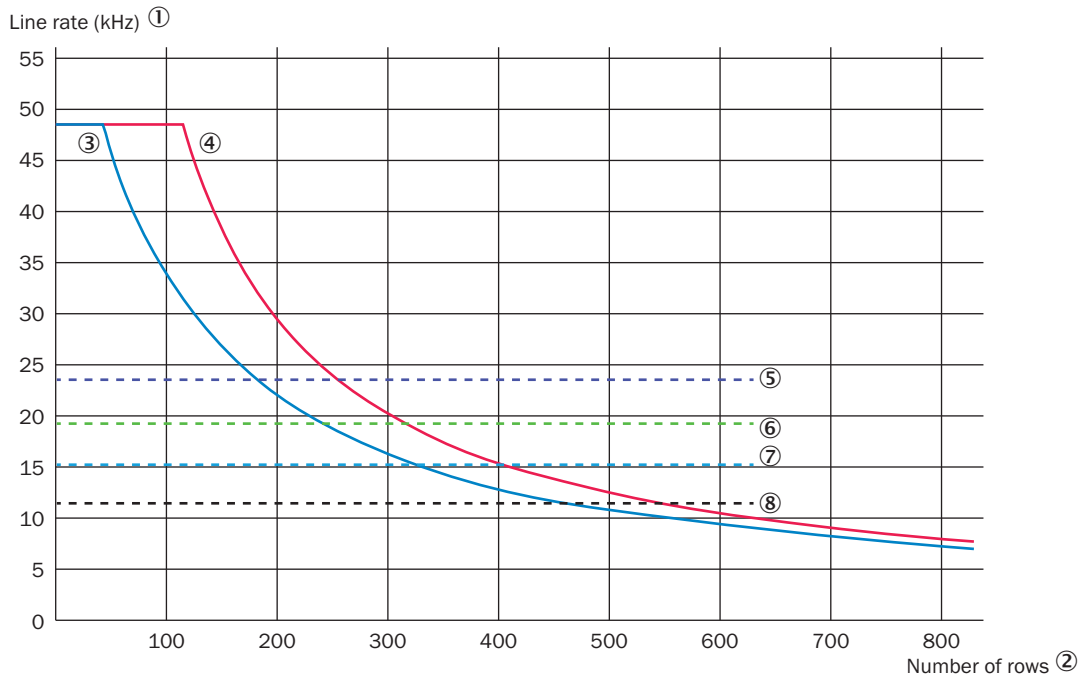



The maximum line rate is based on the number of sensor lines used

- ① Line rate (kHz)
- ② Number of lines
- ③ Ruler3000 with activated HDR

- ④ Ruler3000 without activated HDR
- ⑤ Bandwidth limit for image width 2,560, height range only
- ⑥ Bandwidth limit for image width 3,072, height range only
- ⑦ Bandwidth limit for image width 2,560, height range and reflectance
- ⑧ Bandwidth limit for image width 3,072, height range and reflectance

## Recommended accessories

Other models and accessories → [www.sick.com/Ruler3000](http://www.sick.com/Ruler3000)

	Brief description	Type	part no.
connectors and cables			
	<ul style="list-style-type: none"> <li>• <b>Connection type head A:</b> Female connector, M12, 17-pin, straight, A-coded</li> <li>• <b>Connection type head B:</b> Flying leads</li> <li>• <b>Signal type:</b> Sensor/actuator cable</li> <li>• <b>Cable:</b> 3 m, 17-wire, PUR</li> <li>• <b>Description:</b> Sensor/actuator cable, twisted pair, shielded</li> <li>• <b>Application:</b> Uncontaminated zones, Zones with oils and lubricants, Robot, Drag chain operation</li> </ul>	YF2A2D-030U-V1XLEAX	6042772
	<ul style="list-style-type: none"> <li>• <b>Connection type head A:</b> Male connector, M12, 8-pin, straight, X-coded</li> <li>• <b>Connection type head B:</b> Male connector, RJ45, 8-pin, straight</li> <li>• <b>Signal type:</b> Ethernet, Gigabit Ethernet</li> <li>• <b>Cable:</b> 2 m, 8-wire, PUR, halogen-free</li> <li>• <b>Description:</b> Ethernet, shielded, Gigabit Ethernet</li> <li>• <b>Application:</b> Zones with oils and lubricants</li> </ul>	YM2X18-020EG1M-RJA8	2106258
	<ul style="list-style-type: none"> <li>• <b>Connection type head A:</b> Male connector, M12, 8-pin, straight, X-coded</li> <li>• <b>Connection type head B:</b> Male connector, RJ45, 8-pin, straight</li> <li>• <b>Signal type:</b> Ethernet, Gigabit Ethernet</li> <li>• <b>Cable:</b> 3 m, 8-wire, PUR, halogen-free</li> <li>• <b>Description:</b> Ethernet, shielded, Gigabit Ethernet</li> <li>• <b>Application:</b> Zones with oils and lubricants</li> </ul>	YM2X18-030EG1M-RJA8	2145693

## SICK AT A GLANCE

SICK is one of the leading manufacturers of intelligent sensors and sensor solutions for industrial applications. A unique range of products and services creates the perfect basis for controlling processes securely and efficiently, protecting individuals from accidents and preventing damage to the environment.

We have extensive experience in a wide range of industries and understand their processes and requirements. With intelligent sensors, we can deliver exactly what our customers need. In application centers in Europe, Asia and North America, system solutions are tested and optimized in accordance with customer specifications. All this makes us a reliable supplier and development partner.

Comprehensive services complete our offering: SICK LifeTime Services provide support throughout the machine life cycle and ensure safety and productivity.

For us, that is “Sensor Intelligence.”

## WORLDWIDE PRESENCE:

Contacts and other locations –[www.sick.com](http://www.sick.com)