



V3T12P-MR32A8

TriSpector1000

3D MACHINE VISION

SICK
Sensor Intelligence.



Ordering information

Type	part no.
V3T12P-MR32A8	1091319

Other models and accessories → www.sick.com/TriSpector1000



Detailed technical data

Features

Technology	3D triangulation
Programmable	✓
Pre-calibrated	✓
Toolkit	SICK algorithm API HALCON
Working range	141 mm ... 541 mm
Example field of view	270 mm x 100 mm
Illumination	Integrated
Illumination color	Red, laser, Visible, 660 nm, ± 7 nm
Laser class	2 (EN 60825-1:2014+A11:2021; IEC 60825-1:2014, Complies with the FDA performance requirements for laser products except for conformance with IEC 60825-1 Ed.3., as described in Laser Notice 56 dated May 8, 2019.)
Width at minimum operating distance	90 mm
Width at maximum operating distance	330 mm
Maximum height range	400 mm
Imaging angle	65°
Offline support	Emulator
Task	Detecting - Standard objects Detecting - Level Measuring - Dimension, contour and volume Measuring - Number Monitoring and controlling - Quality Determining position - 3D position determination

Mechanics/electronics

Connection type	M12, 12-pin male connector, A-coded (voltage supply, I/O) M12, 8-pin socket, X-coded (Gigabit Ethernet) M12, 8-pin female connector, A-coded (encoder)
Connector material	Nickel plated brass
Supply voltage	24 V DC, ± 20 %

Ripple	< 5 V _{pp}
Power consumption	≤ 11 W
Current consumption	< 400 mA, without output load
Enclosure rating	IP67
Protection class	III
Housing material	Anodized aluminum
Window material	PMMA
Weight	1.3 kg
Dimensions (L x W x H)	217 mm x 62 mm x 84 mm

Performance

Scan/frame rate	5,000 3D profiles/s
Maximum number of profiles	2,500 Per image
Data points/profile	1,536
Height resolution	40 μm ... 280 μm
3D profile resolution	0.215 mm/px

Interfaces

Ethernet	Function	✓, TCP/IP
	Data transmission rate	FTP, HTTP ≤ 1,000 Mbit/s
Serial		✓, RS-232, RS-422
Operator interfaces		Web server
Configuration software		SICK AppStudio
Digital input		3 inputs
Configurable outputs		4 inputs/outputs
Encoder interface		RS-422 / TTL
Maximum encoder frequency		Max. 300 kHz

Ambient data

Electromagnetic compatibility (EMC)	EN 61000-6-2:2005 / EN 61000-6-3:2007
Shock load	15 g / 6 ms (EN 60068-2-27)
Vibration load	5 g, 10 Hz ... 150 Hz (EN 60068-2-6)
Ambient operating temperature	0 °C ... +50 °C
Storage temperature	-20 °C ... +70 °C ¹⁾

¹⁾ Permissible relative humidity: 0% ... 90% (non-condensing).

Certificates

EU declaration of conformity	✓
UK declaration of conformity	✓
ACMA declaration of conformity	✓
China RoHS	✓
cTUVus certificate	✓
Information according to Art. 3 of Data Act (Regulation EU 2023/2854)	✓

Classifications

ECLASS 5.0	27310205
ECLASS 5.1.4	27310205
ECLASS 6.0	27310205
ECLASS 6.2	27310205
ECLASS 7.0	27310205
ECLASS 8.0	27310205
ECLASS 8.1	27310205
ECLASS 9.0	27310205
ECLASS 10.0	27310205
ECLASS 11.0	27310205
ECLASS 12.0	27310205
ETIM 5.0	EC001820
ETIM 6.0	EC001820
ETIM 7.0	EC001820
ETIM 8.0	EC001820
UNSPSC 16.0901	43211731

Dimensional drawing

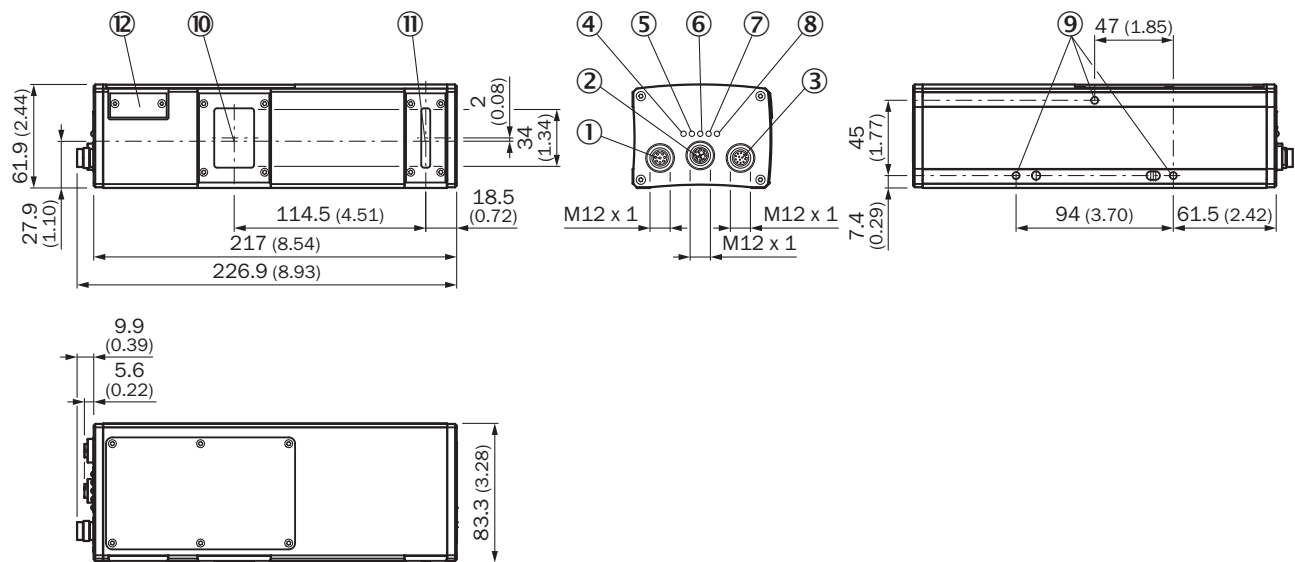

Dimensions in mm (inch)

- ① Connector Encoder (thread inside)
- ② Gigabit Ethernet connection (GbE)
- ③ Connector Power I/O (thread inside)
- ④ LED; On
- ⑤ LED; State
- ⑥ LED; Link/Data
- ⑦ LED; Result
- ⑧ LED; Laser
- ⑨ Fastening threads (M5 x 8.5 mm length)
- ⑩ Optical receiver (center)

- ① Optical sender (center)
- ② Micro SD memory card

Field of view

Typical field of view
TriSpectorP1000

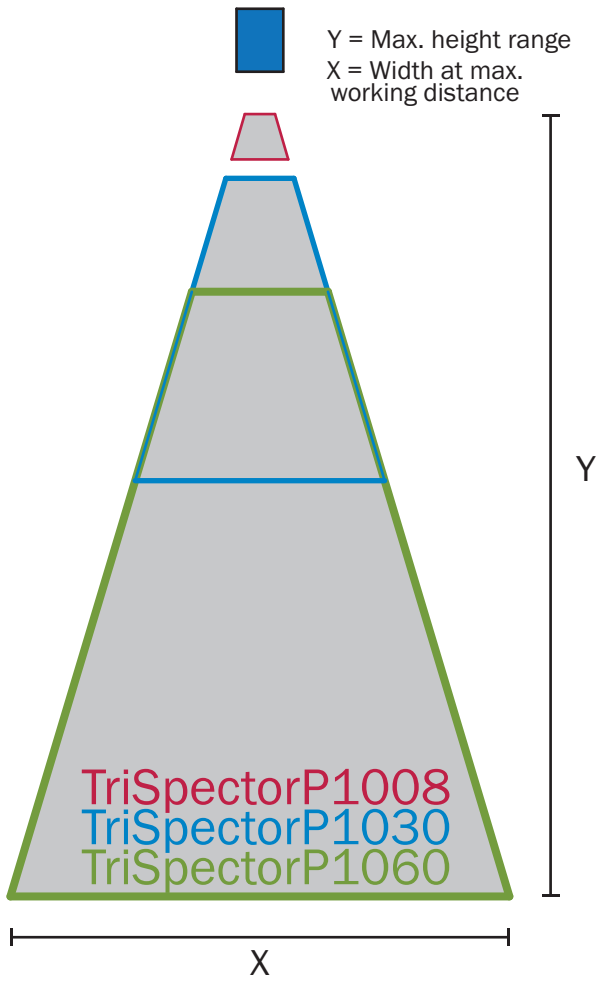

Field of view

TriSpectorP1030

Typ. field of view in mm (inch)

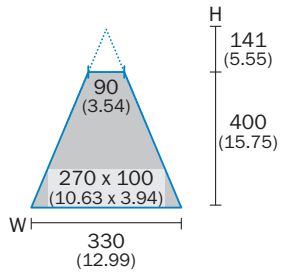

Field of view

Typical field of view

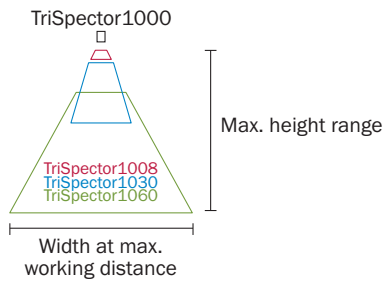







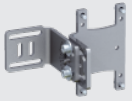

Overview SICK AppSpace



Recommended accessories

Other models and accessories → www.sick.com/TriSpector1000

	Brief description	Type	part no.
Mounting systems			
	<ul style="list-style-type: none"> Description: Mounting bracket set consisting of mounting bracket, cooling plate, includes angle display for setting the tilt angle Suitable for: Lector63x, Inspector63x, Lector83x – up to 40 °C ambient operating temperature, Insepctor83x – up to 40 °C ambient operating temperature, Lector83x – up to 40 °C ambient operating temperature, Insepctor83x – up to 40 °C ambient operating temperature, Lector63x, Inspector63x 	Mounting bracket set with inclination angle -40° - 40°	2076735

	Brief description	Type	part no.
connectors and cables			
	<ul style="list-style-type: none"> • Connection type head A: Female connector, M12, 8-pin, straight, A-coded • Connection type head B: Male connector, M12, 8-pin, straight, A-coded • Signal type: Sensor/actuator cable • Cable: 2 m, 8-wire, PUR, halogen-free • Description: Sensor/actuator cable, shielded • Application: Untaminated zones, Zones with oils and lubricants, Robot, Drag chain operation 	YF2A28-020UA6M2A28	2096105
	<ul style="list-style-type: none"> • Connection type head A: Female connector, M12, 12-pin, straight • Connection type head B: Male connector, M12, 17-pin, straight • Signal type: Power, digital I/Os, serial • Cable: 0.25 m • Description: Power, shielded, Digital I/Os, Serial 	YF2AAB-C25S01M2AAD	2086398
	<ul style="list-style-type: none"> • Connection type head A: Male connector, M12, 5-pin, straight • Connection type head B: Flying leads • Cable: 2 m • Description: Shielded • Connection systems: Flying leads 	Connecting cable	6024860
	<ul style="list-style-type: none"> • Connection type head A: Female connector, M12, 12-pin, straight • Connection type head B: Male connector, M12, 5-pin, straight • Signal type: Power • Cable: 0.25 m • Description: Power 	YF2A6B-C25XXM2A15	2079766
	<ul style="list-style-type: none"> • Connection type head A: Male connector, M12, 8-pin, straight, A-coded • Connection type head B: Flying leads • Signal type: Sensor/actuator cable • Cable: 5 m, 8-wire, PVC • Description: Sensor/actuator cable, shielded • Application: Zones with chemicals, Untaminated zones 	YM2A28-050VA6XLEAX	2096233
	<ul style="list-style-type: none"> • Connection type head A: Male connector, M12, 8-pin, straight, X-coded • Connection type head B: Male connector, RJ45, 8-pin, straight • Signal type: Ethernet, Gigabit Ethernet • Cable: 2 m, 8-wire, PUR, halogen-free • Description: Ethernet, shielded, Gigabit Ethernet • Application: Zones with oils and lubricants 	YM2X18-020EG1M-RJA8	2106258
	<ul style="list-style-type: none"> • Connection type head A: Male connector, M12, 8-pin, straight, X-coded • Connection type head B: Male connector, RJ45, 8-pin, straight • Signal type: Ethernet, Gigabit Ethernet • Cable: 3 m, 8-wire, PUR, halogen-free • Description: Ethernet, shielded, Gigabit Ethernet • Application: Zones with oils and lubricants 	YM2X18-030EG1M-RJA8	2145693

SICK AT A GLANCE

SICK is one of the leading manufacturers of intelligent sensors and sensor solutions for industrial applications. A unique range of products and services creates the perfect basis for controlling processes securely and efficiently, protecting individuals from accidents and preventing damage to the environment.

We have extensive experience in a wide range of industries and understand their processes and requirements. With intelligent sensors, we can deliver exactly what our customers need. In application centers in Europe, Asia and North America, system solutions are tested and optimized in accordance with customer specifications. All this makes us a reliable supplier and development partner.

Comprehensive services complete our offering: SICK LifeTime Services provide support throughout the machine life cycle and ensure safety and productivity.

For us, that is “Sensor Intelligence.”

WORLDWIDE PRESENCE:

Contacts and other locations –www.sick.com